



Manufacturer's Representative for the HVAC Industry Since 1977

STOCK CATALOG

Access Doors

Accessories

Actuators

Backdraft Dampers

Control Dampers

Diffusers/Screens

Duct Silencers

Fans

Fire/Smoke Dampers

Louvers

Registers/Grilles

Smoke Detectors

Terminal Units

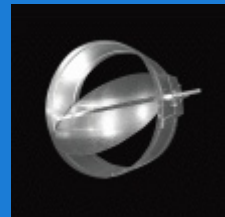
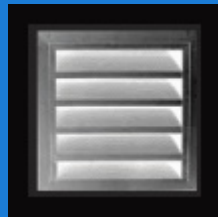
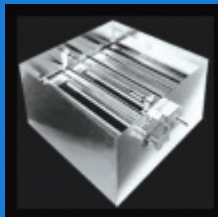
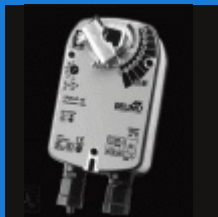
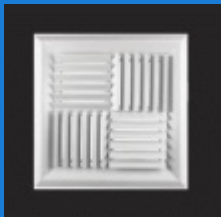

PRODUCT LINES

- Access Doors & Panels
- Air Control Dampers
- Air Doors
- Air Distribution
- Architectural Louvers & Penthouses
- Architectural Screens & Grilles
- Backdraft Dampers
- Fans & Blowers
- Roof/Smoke Hatches
- Electric Duct Heaters
- Fire & Smoke Dampers
- Gravity Ventilators
- Kitchen Exhaust Systems
- Motors
- Controls & Damper Accessories
- Sound Attenuators & Enclosures
- VAV Terminal Units
- Security Grilles & Bars

MANUFACTURES



TABLE OF CONTENTS

Dampers

Fire/Smoke Dampers.....	1
Vertical Curtain Dampers.....	2
Square to Round Adaptors.....	2
Ceiling Radiation Dampers.....	3
Mounting Angles.....	3
Air Control Dampers.....	4
Backdraft Dampers.....	5
Damper Accessories.....	6

Actuators & Accessories

U.L. Actuators.....	7-9
Pneumatic Actuator.....	7-9
Smoke Detectors.....	10

Access Doors & Roof Hatches

Exterior Access Panel.....	11
Stock Drywall Access Doors.....	12
Duct Access Doors.....	13-15

Terminal Units

Single Duct Terminal Units.....	16-17
VAV Accessories.....	18

Air Distribution

Linear Slot Diffusers.....	19
Insulated Diffuser Plenum.....	19
Perforated Lay-In Diffusers.....	20-22

Air Distribution (cont.)

Perforated Lay-In Screens.....	22
Perforated Surface Mount.....	23
Modular Core Diffusers.....	24
Architectural Ceiling Diffuser Lay-In.....	24
Louvered Face Ceiling Diffuser.....	25
Curved Blade Ceiling Diffuser.....	25
Thermally Powered VAV Diffuser.....	25
Round Neck Louver Diffuser Lay-In.....	26
Round Face Fixed Cone Diffuser.....	26
Fixed Bar Return Grille.....	27
Bar Style Filter Grille.....	27
Double Deflection Registers.....	28
Steel Auxiliary Frame.....	28
Aluminum Egg-Crate Grilles.....	29
Single Deflection Registers.....	29
Louvers.....	30

Diffuser Accessories

Round Opposed Blade Damper.....	31
Square Opposed Blade Damper.....	31
Round Neck Opposed Blade Damper.....	31

FIRE/SMOKE DAMPERS - 5 YEAR WARRANTY

One Product - Multiple Applications

- Vertical walls.
- UL 555 & 555S class II leakage rated.
- 16" inch long, 20 gauge galvanized sleeve.
- 1-1/2" hour (vertical & horizontal).
- UL file #R11767.
- C.S.F.M file #3225-0368:110 fire rated, 3230-0368:111 leakage rated.
- Optional SSPF single sided retaining angle or loose flange (for use with air distribution).
- All units available with optional round collars shipped loose.
- All dampers supplied with Belimo 120 VAC (24 VAC available) actuators.



FSD-172 - Wall Application

- 1 hour rating for tunnel type corridor ceiling construction.
- UL 555 & 555S class II leakage rated.
- 16" inch long, 20 gauge galvanized sleeve.
- UL file #R11767.
- C.S.F.M. file #3225-0368:110 fire rating, 3230-0368:111 leakage rating.
- Optional SSPF single sided retaining angle or loose flange (for use with air distribution).
- All units available with optional round collars shipped loose.
- All dampers supplied with Belimo 120 VAC (24 VAC available actuators).
- See optional available accessories.



FSD-172 - Corridor Ceiling Application

Accessory Reference

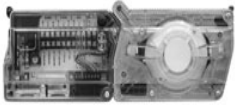

Smoke Detector - pg. 12



Actuators - pg. 9-10



Access Doors - pg. 13-17



SSPF Angles - pg. 5

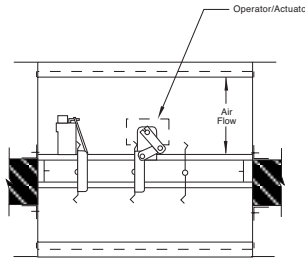

Horizontal Mount

The Model FSD-172 is cross listed for installation in one and two hour rated walls for vertical mounting. It is also listed for installations in one hour rated tunnel corridor ceilings.

Size	Stock#
6"x6"	W-11694
8"x8"	W-11695
10"x10"	W-11696
12"x12"	W-11697
14"x14"	W-11698
16"x16"	W-11699
18"x18"	W-11700
20"x20"	W-11701
22"x22"	W-11702
24"x24"	W-11703

Single Mounting Angle Over Drywall

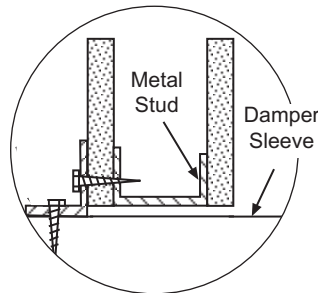

Single Mounting Angle UNDER Drywall * Metal Stud Only

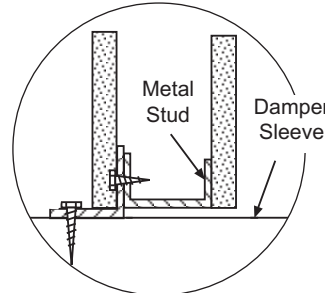

Mounting Angles

SSPF Mounting Angles

The exclusive single-side mounting angle design only requires angles on one side of partition. The ingenious corner design allows this mounting system to install either underneath or on top of the drywall offering additional installation options and cost savings. Tested and approved in accordance with U.L. standard 555 this unique system is in full compliance with all building codes for wood stud, metal stud or masonry installations.

VERTICAL FIRE DAMPERS - 5 YEAR WARRANTY



VFD-10D-A

- “A” style dynamic dampers stocked.
- Wall style vertical mount for 1 or 2 hour walls.
- 12", 20 gauge galvanized integral steel sleeve.
- U.L. file #R11767.
- C.S.F.M. file #3225-0368:101.
- Optional SSPF picture frame angles.
- Optional round collar(s) shipped loose.
- Optional loose flange for use with air distribution.

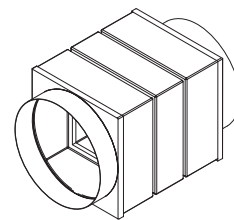

Vertical Mount
(Model - VFD-10D-ISAR shown above.
Optional round duct connection is a U.L. approved breakaway connection.)

Size	Stock#
6" x 6"	W-11617
8" x 8"	W-11618
10" x 10"	W-11619
12" x 12"	W-11620
14" x 14"	W-11621
16" x 16"	W-11622
18" x 18"	W-11623
20" x 20"	W-11624
22" x 22"	W-11625
24" x 24"	W-11626

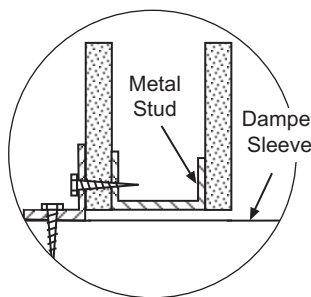

Single Mounting Angle
Over Drywall

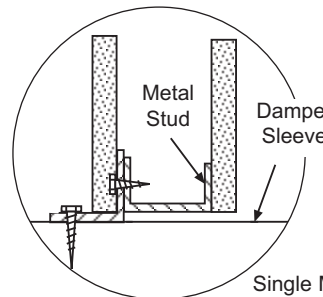

Single Mounting Angle
UNDER Drywall
* Metal Stud Only

Mounting Angles



FIRE/SMOKE DAMPERS AND FIRE DAMPERS SQUARE-TO-ROUND ADAPTORS



- The Fire/Smoke Dampers and Fire Dampers Square-to-Round Caps will not fit on the Ceiling Radiation Dampers.

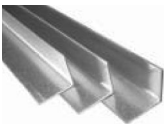

Size	Stock#
6"x6"x6"	W-11637
8"x8"x6"	W-11638
8"x8"x8"	W-11639
10"x10"x8"	W-11640
10"x10"x10"	W-11641
12"x12"x10"	W-11642
12"x12"x12"	W-11643
14"x14"x12"	W-11644
14"x14"x14"	W-11645
16"x16"x14"	W-11646
16"x16"x16"	W-11647
18"x18"x16"	W-11648
18"x18"x18"	W-11649
20"x20"x18"	W-11650
20"x20"x20"	W-11651
22"x22"x20"	W-11652
22"x22"x22"	W-11653
24"x24"x22"	W-11654
24"x24"x24"	W-11655

Accessory Reference		
		
SSPF Angle - pg. 5	Access Doors - pg. 13-17	Warnock Hersey Angle Set - pg.5

CEILING RADIATION DAMPERS - 5 YEAR WARRANTY

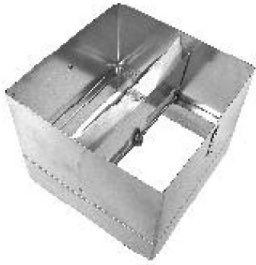

CFD-15-ES

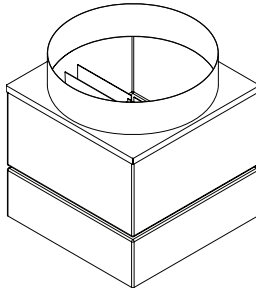

Optional round duct transition on top

Ceiling radiation dampers are for use in floor-ceiling and roof-ceiling assemblies. They are constructed of 22 gauge galvanized steel and are stocked with an extended sleeve.

- UL Listing: R14603
- CSFM Listing: 3226-0368:104
- U.L. file no. 3225-368:104.
- CRB-24 24" x 24" radiation blankets for use with T-bar ceiling diffusers.
- Stocked NET ID only
- Warnock Hersey listing: WH1-495-PSH0177,-0178
- Meets NFPA Standards: 90A & 101
- Meets building code standards: IBC, NBC, NFPA, SBC & UBC

Size	Stock#
6"x6"	W-11742
8"x8"	W-11743
10"x10"	W-11744
12"x12"	W-11745
14"x14"	W-11746
16"x16"	W-11747
18"x18"	W-11748
20"x20"	W-11749
22"x22"	W-11750
24"x24"	W-11751
CRB-24	W-11731



WARNOCK HERSEY MOUNTING ANGLES, FOR CFD'S ONLY

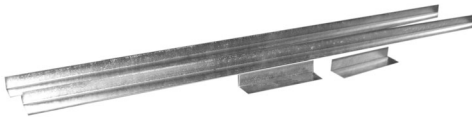

Cat#	Size
W-12446	2 pcs-1"x1/2"x28" Long x 20 ga. 2 pcs-1"x1/2"x3" Long x 20 ga.

LOOSE FLANGE STOCK - For FSD's, VFD's AND CFDs

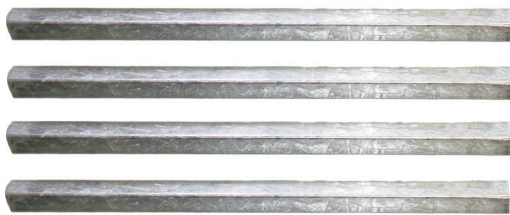

Cat#	Size
W-12678	6"x6"
W-12679	8"x8"
W-12680	10"x10"
W-12681	12"x12"
W-12682	14"x14"
W-12683	16"x16"
W-12684	18"x18"
W-12685	20"x20"
W-12686	22"x22"
W-12687	24"x24"

SSPF MOUNTING ANGLES - For VFD's and FSD's Only.



Cat#	Size
W-11786	6"x6"
W-11787	8"x8"
W-11788	10"x10"
W-11789	12"x12"
W-11790	14"x14"
W-11791	16"x16"
W-11792	18"x18"
W-11793	20"x20"
W-11794	22"x22"
W-11795	24"x24"

CONTROL DAMPERS - 5 YEAR WARRANTY



CD-42

- Single and opposed blade action available.
- 6" x 16 gauge galvanized steel blades.
- 1/2" dia. hex plated steel blade shafts.
- In-jamb linkage.
- Standard nylon bushings.
- 1/2" round x 6" drive axle with bearing.
- Dampers supplied 1/4" undersized.
- Optional electric and pneumatic actuators in stock (see accessory reference.)
- Optional manual locking quadrant (see accessory reference.)

Size	Stock#
6" x 6"	W-11917
8" x 8"	W-11918
10" x 10"	W-11919
12" x 12"	W-11920
14" x 14"	W-11921
16" x 16"	W-11922
18" x 18"	W-11923
20" x 20"	W-11924
22" x 22"	W-11925
24" x 24"	W-11926



CD-10R

- 6" x 22 gauge sleeve and blade.
- Double beaded for strength.
- Easy duct connection.
- 22 gauge galvanized blade with center "V".
- 3/8" square zinc plated shafts with tight sealing nylon bushings.
- Manual locking quadrant standard with 1-1/2" stand-off bracket.
- No rattles.

Size	Stock#
6"	W-11879
7"	W-12392
8"	W-11880
9"	W-12393
10"	W-11881
12"	W-11882
14"	W-11883
16"	W-11884
18"	W-11885
20"	W-11886
22"	W-11887
24"	W-11888



CD-25R

- 12" x 20" gauge galvanized steel sleeve.
- Double beaded for strength and easy duct connection.
- Double membrane steel blade (14 ga. equivalent).
- Polyethylene blade gasket provides full diameter seal.
- 1/2" round diameter steel blade shafts.
- Leakage less than 1% at 2" of static pressure.
- Maintains seal at 4" of static pressure.
- Optional electric and pneumatic actuators in stock.
- Optional manual locking quadrant (see accessory reference.)

Size	Stock#
6"	W-11889
8"	W-11890
10"	W-11891
12"	W-11892
14"	W-11893
16"	W-11894
18"	W-11895
20"	W-11896
22"	W-11897
24"	W-11898

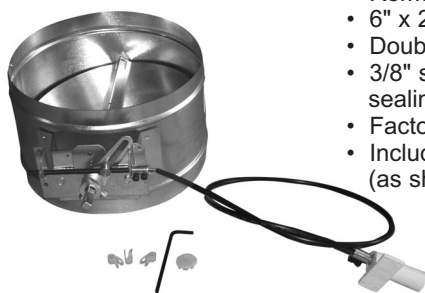

RCS-10R

- Remote controlled cable operated balancing damper.
- 6" x 22 gauge galvanized steel blade and sleeve.
- Double beaded for strength.
- 3/8" square zinc plated steel blade shafts with tight sealing nylon bushings.
- Factory assembled (no field assembly required.)
- Includes 36" cable and remote operator (as shown) (longer lengths available.)

Size	Stock#
6"	W-12380
7"	W-12381
8"	W-12382
9"	W-12383
10"	W-12384
12"	W-12385
14"	W-12386
16"	W-12387
18"	W-12388
20"	W-12389
22"	W-12390
24"	W-12391
Field Mt. Kit	W-12395
Extra Cable	W-12377
Ex. Insulation	W-12378

* Included with W-12377

Accessory Reference



Damper Accessories - pg. 8



Actuators - pg. 9-10

RCS-10R FIELD MOUNTING KIT



RCS-10R Field Mounting Kit

- Control arm/screw assembly - mounted on standoff bracket.
- Standard 36" long cable included (optional cable lengths available.)
- Allen key remote control assembly can be provided loose for use with almost any balancing damper.
- Standard 15/16" O.D. provides unobtrusive opening in ceiling or wall for architectural requirements.

BACKDRAFT DAMPERS



BD-130

5 YEAR WARRANTY

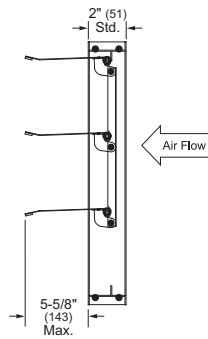

Vertical Mount

The BD-130 is constructed with 1-7/8" x 13/16" x 0.081" extruded aluminum channel frame and 0.05" thick aluminum extruded blades. They feature synthetic bearings and blade axes. They are constructed for vertical mounting and horizontal upflow.

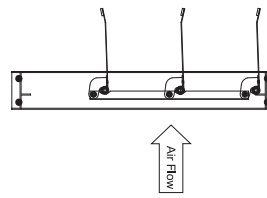

Horizontal Mount

Size	Stock#
6"x6"	W-11899
8"x8"	W-11900
10"x10"	W-11901
12"x12"	W-11902
14"x14"	W-11903
16"x16"	W-11904
18"x18"	W-11905
20"x20"	W-11906
22"x22"	W-11907
24"x24"	W-11908

- Aluminum tie bar interconnects all blades for increased stability at higher velocities up to 1500 fpm
- Blade edge extruded vinyl seals reduce leakage and noise
- Units supplied approximately 1/4" under nominal duct dimension



BDR

The BDR is constructed with 20 gauge steel frame and sleeve with aluminum spring loaded blades. They are constructed for vertical mounting and horizontal upflow.

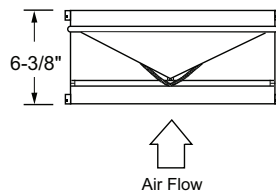

Air Flow

Size	Stock#
4"	W-11909
6"	W-11911
7"	W-11912
8"	W-11913
10"	W-11914
12"	W-11915
14"	W-11916
16"	W-12281

- Neoprene closed cell gaskets around frame.
- Designed for low air flow gravity and fan usage less than 600 FPM.

DAMPER ACCESSORIES

U.L. DAMPER ACCESSORIES

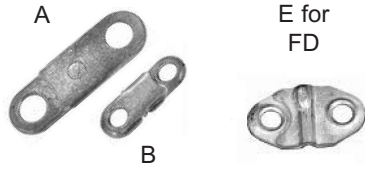

FUSIBLE

Size	Stock#
A Style, 165 Degree	W-12099
A Style, 212 Degree	W-12100
B Style, 165 Degree	W-12103
B Style, 212 Degree	W-12104
E Style, 165 Degree	W-12420
E Style, 212 Degree	W-12421
Starlink, 165 Degree	W-12422
Fusible Link Hook	W-12445



Size	Stock#
RCP-1 Toggle	W-10087
RCP-1K Key	W-10088
RCP-M Momentary	W-12694
RDT-Remote Damper Tester	W-10089
RLP-1 One Light Indicator	W-12688
RLP-2 Two Light Indicator	W-12689
HS-10 Replacement Assy	W-12690



FD & FSD LABELS

Size	Stock#
Fire Damper, Single Label	W-12423
Fire Damper, 500 Piece Roll	W-12424
Fire/Smoke, Single Label	W-12425
Fire/Smoke, 500 Piece Roll	W-12426



SWITCHES



TESTER



HIGH BLADE BRACKET

Size	Stock#
1/2" RD. Damper Drive Arms	W-12428
High Blade Brackets	W-12429
Low Blade Brackets	W-12430
Ball Joint Swivels	W-12432
1/2" Damper Drive w/ U-clip, 6"	W-12447
5/16" Brass Trunion	W-12431
5/16" Steel Rod, Zinc, per foot	W-12427
1/2" Steel Rod, Zinc, per foot	W-12434
3/4" Steel Rod, Hollow, Zinc, per foot	W-12437
Damper Blade Jumper Strap	W-12433



LOW BLADE BRACKET

5/16" Connecting Rod



DAMPER DRIVE



BALL JOINT SWIVEL



Size	Stock#
S.S. Steel Oilite Bearing, 1/2" Round	W-12438
Synthetic Bearing, 1/2" Round	W-12439
Synthetic Bearing, 3/8" Square	W-12441

BUSHING/BEARINGS



Size	Stock#
Blade Edge Seal, Bulb, per foot	W-12442
Blade Edge Seal, Closed Cell, per foot	W-12443

BLADE EDGE SEAL



MANUAL QUADRANTS

Size	Stock#
LQ-355, 3/8" Square	W-10092
LQ-560, 1/2" Round	W-10095
LQ-555, 1/2" Square	W-10096

ACTUATORS

U.L. FIRE/SMOKE DAMPER ELECTRIC ACTUATORS - 350° DEGREE RATING

BELIMO

5 YEAR WARRANTY



The type FSNF and FSLF spring-return actuators are intended for the operation of smoke and combination fire and smoke dampers in ventilation and air-conditioning systems. The actuator will meet requirements of UL555 and UL555S when tested as an assembly with the damper and will meet requirements of UBC for 15 second opening and closing at 350°F.

Square footage of damper operated will depend on the model required.

FSNF-120

Catalog#	Model#	Max.Sq.Ft.	Voltage	Power	Aux. Switch	Description
W-11986	FSLF-120	6	120 VAC	11(R), 7(H)	No	2-Position, Spring Return
W-12025	FSLF-120-S	6	120 VAC	11(R), 7(H)	Yes	2-Position, Spring Return
W-11991	FSNF-120	16.5	120 VAC	18(R), 6(H)	No	2-Position, Spring Return
W-11993	FSNF-120-S	16.5	120 VAC	18(R), 6(H)	Yes	2-Position, Spring Return
W-11992	FSNF-24	16.5	24 VAC	18(R), 6(H)	No	2-Position, Spring Return
W-11987	FSNF-24-S	16.5	24 VAC	18(R), 6(H)	Yes	2-Position, Spring Return
W-12031	FSLF-24	6	24 VAC	3(R), 2(H)	No	2-Position, Spring Return
W-12026	FSLF-24-S	6	24 VAC	3(R), 2(H)	Yes	2-Position, Spring Return
W-12674	FSAF-120	24	120 VAC	9.5/3.5	No	2-Position, Spring Return
W-12675	FSAF-120-S	24	120 VAC	9.5/3.5	Yes	2-Position, Spring Return
W-12676	FSAF-24	24	24 VAC	9.5/3.5	No	2-Position, Spring Return
W-12677	FSAF-24-S	24	24 VAC	9.5/3.5	Yes	2-Position, Spring Return

U.L. FIRE/SMOKE DAMPER PNEUMATIC ACTUATORS - 350° DEGREE RATING

SIEMENS



331-4826

The 331-4826 Pneumatic Damper Actuator is a compact, modular, totally enclosed, rolling diaphragm-type actuator designed for modulating or two position actuation. Typical applications are for control and fire/smoke leakage rated dampers or air valves.

The 331-2998 Pneumatic Actuator Damper Actuator is a totally enclosed, pneumatic piston type actuator designed to operate dampers for ventilating systems, mixing box control, and other applications requiring a large effective diaphragm area and long stroke.

SIEMENS



331-2998

Catalog#	Model#	Max.Sq.Ft.	Pressure	Power	Aux. Switch	Description
W-10547	331-4826	4	8 - 13 PSI	Pneumatic	No	The No. 3 Pneumatic Damper Actuator is a Compact, Modular, Totally Enclosed, Rolling Diaphragm-Type Actuator Designed for Modulating or Two Position Actuation.
W-10548	331-2998	12	8 -13 PSI	Pneumatic	No	The No. 3 Pneumatic Damper Actuator is a Compact, Modular, Totally Enclosed, Rolling Diaphragm-Type Actuator Designed for Modulating or Two Position Actuation.

ACTUATORS

ELECTRIC ACTUATORS - 2 POSITION SPRING RETURN - FOR USE WITH AIR CONTROL DAMPERS 5 YEAR WARRANTY

BELIMO



LF



NF/AF

Catalog#	Model#	Max.Sq.Ft.	Voltage	Power	Aux. Switch	Description
W-10554	AF-120-US	80/40 (w/seals)	120	6(R), 2.3(H)	No	2-Position, Spring Return
W-12002	AF-120-S-US	80/40 (w/seals)	120	6(R), 2.3(H)	Yes	2-Position, Spring Return
W-10555	AF-24-US	80/40 (w/seals)	24	5(R), 1.5(H)	No	2-Position, Spring Return
W-12005	AF-24-S-US	80/40 (w/seals)	24	5(R), 1.5(H)	Yes	2-Position, Spring Return
W-10550	LF-120-US	20/10 (w/seals)	120	5.5 (R), 3.5(H)	No	2-Position, Spring Return
W-12000	LF-120-S-US	20/10 (w/seals)	120	5.5(R), 3.5(H)	Yes	2-Position, Spring Return
W-10551	LF-24-US	20/10 (w/seals)	24	5(R), 2.5(H)	No	2-Position, Spring Return
W-12003	LF-24-S-US	20/10 (w/seals)	24	5(R), 2.5(H)	Yes	2-Position, Spring Return
W-10552	NFUBP-120-US	40/20 (w/seals)	120	6(R), 3.5(H)	No	2-Position, Spring Return
W-12001	NFUB-120-S	40/20 (w/seals)	120	6(R) 3.5(H)	Yes	2-Position, Spring Return
W-10553	NFB-24	40/20 (w/seals)	24	5(R), 2.6(H)	No	2-Position, Spring Return
W-12004	NFB-24-S	40/20 (w/seals)	24	5(R), 2.6(H)	Yes	2-Position, Spring Return
W-12449	TF-120-US	10/5 (w/seals)	120	2(R), 1.3(H)	No	2-Position, Spring Return
W-12451	TF-120-S-US	10/5 (w/seals)	120	2(R), 1.3(H)	Yes	2-Position, Spring Return
W-12450	TF-24-US	10/5 (w/seals)	24	2(R), 1.3(H)	No	2-Position, Spring Return
W-12452	TF-24-S-US	10/5 (w/seals)	24	2(R), 1.3(H)	Yes	2-Position, Spring Return

ELECTRIC ACTUATORS - PROPORTIONAL SPRING RETURN

5 YEAR WARRANTY

For position control, fail-safe control of dampers in HVAC systems. Control is positional from an auxiliary contact, or a manual switch. These actuators provide true spring return operation for reliable application and positive close off on airtight dampers. The spring return system provides constant torque to the damper with, and without, power applied to the actuator.



NF/AF

Catalog#	Model#	Max.Sq.Ft.	Voltage	Power	Aux. Switch	Description
W-12454	AFX-24-MFT-US	80/40 (w/seals)	24 vac (2-10vdc)	6(R), 1.8(H)	No	Proportional Spring Return
W-10557	AFX-24-MFT-S-US	80/40 (w/seals)	24vac (2-10vdc)	6(R), 1.8(H)	Yes	Proportional Spring Return
W-12453	NFB-24-SR-US	40/20 (w/seals)	24vac (2-10vdc)	3(R),1(H)	No	Proportional Spring Return
W-10556	NFB-24-SR-S-US	40/20 (w/seals)	24vac (2-10vdc)	3(R),1(H)	Yes	Proportional Spring Return

ELECTRIC ACTUATORS-PROPORTIONAL NON SPRING RETURN

5 YEAR WARRANTY

2-10 VDC OR 4-20 mA CONTROL SIGNAL



LM



AM

Catalog#	Model#	Max.Sq.Ft.	Voltage	Power	Aux. Switch	Description
W-10560	AMX24-MFT	40/30 (w/seals)	24vac(2-10vdc)	4(R), 1.25(H)	No	Proportional, Programming Available
W-12459	AMB24-SR	40/30 (w/seals)	24vac(2-10vdc)	4(R), 1.25(H)	Add-On	Proportional
W-12460	AMB24-3	40/30 (w/seals)	24vac	4(R), 1.25(H)	Add-On	Modulating, Floating Point
W-10561	GMB24-SR	70/50 (w/seals)	24vac(2-10vdc)	4.5(R), 2(H)	Add-On	Proportional
W-12461	GMB24-3	70/50 (w/seals)	24vac	4.5(R), 2(H)	Add-On	Modulating, Floating Point
W-10558	LMB24-SR	15/6 (w/seals)	24vac(2-10vdc)	1.5(R), 0.5(H)	Add-On	Proportional
W-12462	LMB24-3	15/6 (w/seals)	24vac	1.5(R), 0.5(H)	Add-On	Modulating, Floating Point
W-12463	LMX24-MFT	15/6 (w/seals)	24vac(2-10vdc)	1.5(R), 0.5(H)	No	Proportional, Programming Available
W-12464	NMB24-3	50/25 (w/seals)	24vac	2.5(R), 0.5(H)	Add-On	Modulating, Floating Point
W-12465	NMB24-SR	50/25 (w/seals)	24vac(2-10vdc)	2.5(R), 0.5(H)	Add-On	Proportional

PNEUMATIC ACTUATORS

PROPORTIONAL OR 2 POSITION

KREUTER



MCP-3631

The 331-4826 Pneumatic Damper Actuator is a compact, modular, totally enclosed, rolling diaphragm-type actuator designed for modulating or two position actuation. Typical applications are for control and fire/smoke leakage rated dampers or air valves.

- Fixed or pivot mounting models.
- Position relay available as an option.
- Variety of mounting/linkage kits to fit any application.
- Threaded shaft for easy mounting of accessory items.

SIEMENS



331-4826

Catalog#	Model#	Spring Range	Description
W-51160	MCP-3631-3000	5-10 PSI	Pneumatic, Proportional or 2 Position
W-10547	331-4826	8-13 PSI	Pneumatic, Proportional or 2 Position
W-10548	331-2998	8-13 PSI	Pneumatic, Proportional or 2 Position



SYSTEM SENSORS

SYSTEM SENSOR D4120 LOW FLOW SMOKE DETECTOR

D4120



- Outside mounting tabs.
- Patented telescoping sampling tube.
- Built-in reset button.
- Interconnectability for multi-fan shutdown (up to fifty air handlers).
- Patented cover tamper trouble signal.
- Easy to clean.
- 24 VAC/DC or 120/VAC operation.
- High-Low voltage barrier.
- UL 268A listed.
- 1 year warranty

Catalog#	Model#	Description
W-12660	D4120	Smoke Detector
W-12661	DST 1.5	1.5 Foot Sampling Tube
W-12662	DST 3	3 Foot Sampling Tube
W-12663	DST 5	5 Foot Sampling Tube
W-12664	DST-10	10 Foot Sampling Tube

SAMPLING TUBE FOR ABOVE DETECTOR



SYSTEM SENSOR 2151 LOW VELOCITY PHOTOELECTRIC (NO FLOW/LOW FLOW) DUCT DETECTOR

2151



- Low profile smoke detector design.
- Low standby current.
- Two LED's "blink" in stand by.
- Detector head plugs easily into base.
- Built-in test switch.
- Built-in tamper-resistant feature.
- Air velocity rating 0 to 3000 FPM.
- 120VAC base with built-in shorting spring.
- Designed for mounting on standard electrical box.
- SEM screws for easy wiring and positive wire retention.
- Removable cover and insect screen for field cleaning.
- UL 268A listed.

Catalog#
W-10564

SMOKE DETECTOR BASE UNIT

B114LP

- 120 VAC base unit for use with 2151 above.

B114LPBT

- 24 VAC/DC base unit for use with 2151 above.



Model#	Catalog#
B114LP	W-10565
B114LPBT	W-12652

SYSTEM SENSOR CARBON MONOXIDE DETECTOR

- UL 2075
- 12/24 VDC
- Wall or ceiling mounted.
- Code required trouble relay.
- Electro Chemical sensing.



CO1224

Catalog#
W-12478

Accessory Reference



Required to be used with 2151 detector for in-duct installations. Also works with D4120.

RTS451 Remote Test Station

Catalog#
W-12476

EXTERIOR ACCESS PANEL: MODEL XPA



XPA

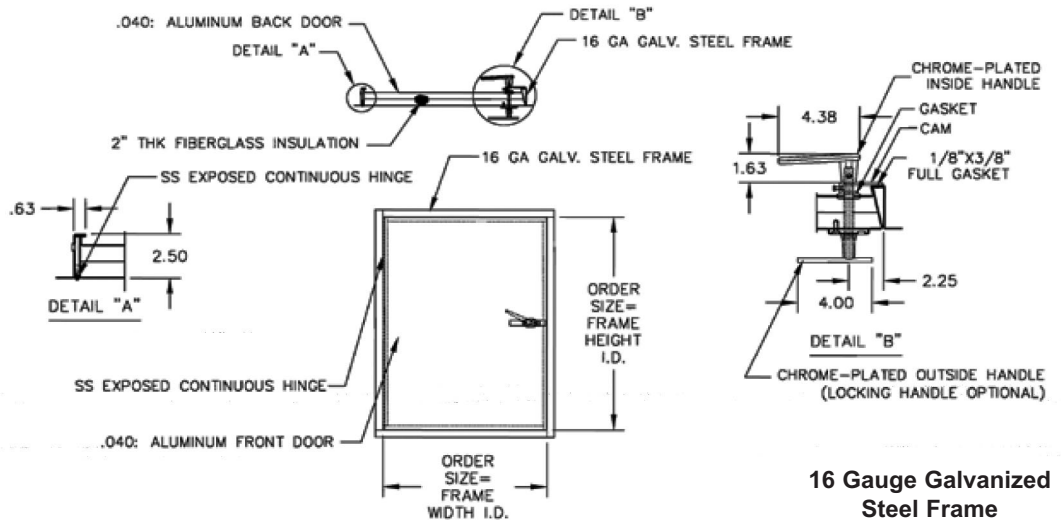

16 Gauge Galvanized Steel Frame

Stainless Steel is also available - Call for Pricing

SPECIFICATIONS: MODEL XPA

- Door: 2" Thick Insulated .040 Aluminum Door.
- Flange: 1" - 16 Ga. Galvanized Steel.
- Exterior Hinge: Stainless Steel.
- Gasketing: EPDM Foam Rubber Bulb Seal.
- Handles: Locking and Non-Locking, Zinc Die Cast with Chrome Plating.
- Handles are factory installed. Panels Are Ready For Installation.
- Finish: Powder Coat Gray Primer.

Catalog#	Size	Wall Opening	No. Handles
W-12479	12"x12"	12-3/8"x12-3/8"	1
W-12480	14"x14"	14-3/8"x14-3/8"	1
W-12481	18"x18"	18-3/8"x18-3/8"	1
W-12482	24"x24"	24-3/8"x24-3/8"	2
W-12483	24"x36"	24-3/8"x36-3/8"	2
W-12484	24"x48"	24-3/8"x48-3/8"	2
W-12485	30"x30"	30-3/8"x30-3/8"	2
W-12486	36"x48"	36-3/8"x48-3/8"	2

*For key lock on above doors add \$25.00 list.

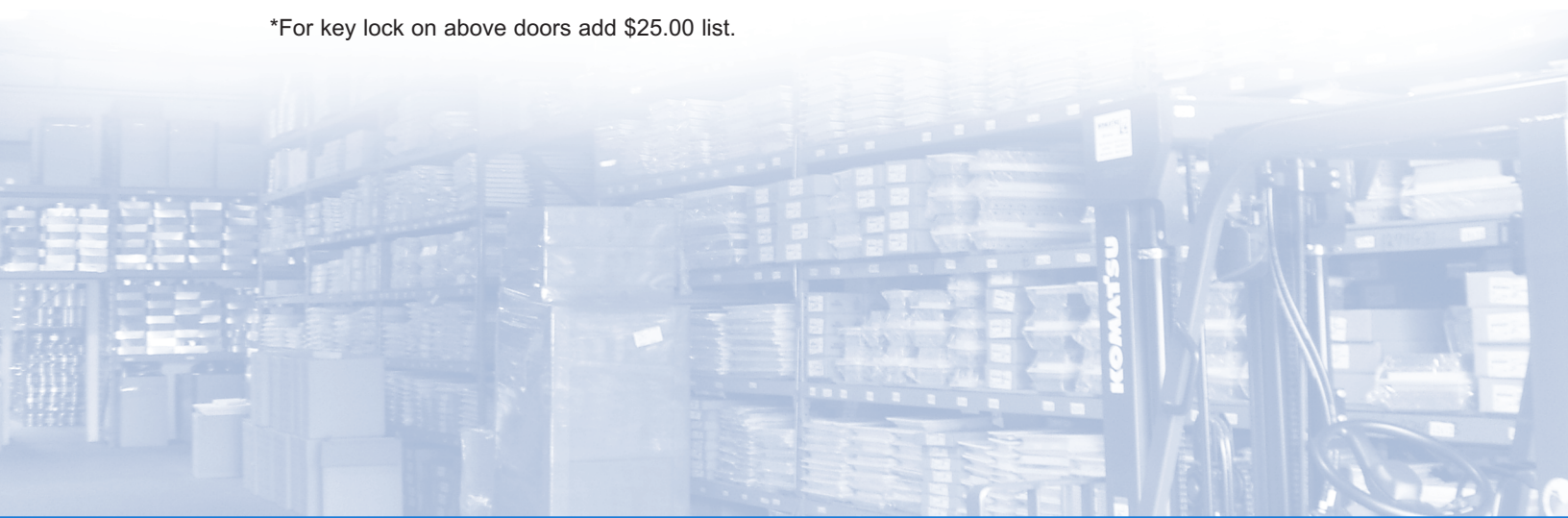

STOCK DRYWALL ACCESS DOORS

TM - GENERAL PURPOSE INTERIOR ACCESS DOOR



TM

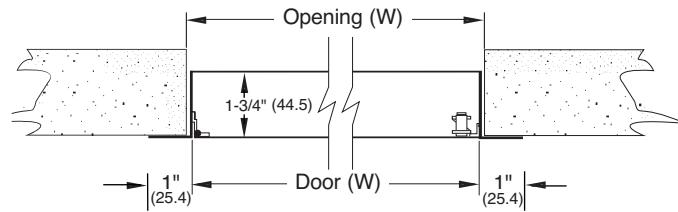

Catalog#	Size
W-11493	8" X 8"
W-11495	10" X 10"
W-11496	12" X 12"
W-11500	14" X 14"
W-11501	16" X 16"
W-11503	18" X 18"
W-11506	24" X 24"
W-11507	24" X 36"

- For Masonry, tile, and wallboard.
- 16 gauge door and frame.
- Screwdriver operated cam locks.
- Steel construction.
- Phosphate dipped with gray prime coat.
- Concealed hinge on long dimension.
- Cut opening 3/8" larger than nominal.
- Custom sizes and colors also available - Just Ask Us!!!
- Can be ordered with Keylock option.*

* Add \$20.00 list to above doors for key option.

FD - FIRE RATED ACCESS DOOR

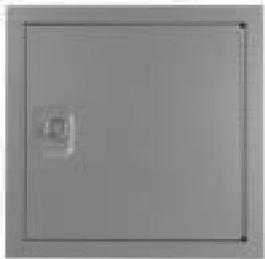

FD

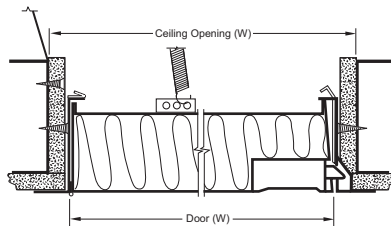

Typical Ceiling Installation

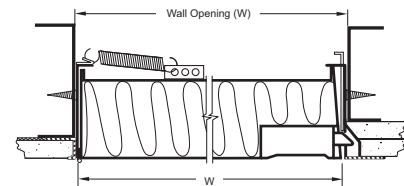

Typical Wall Installation

Catalog#	Size
W-11455	8" X 8"
W-11456	10" X 10"
W-11457	12" X 12"
W-11458	14" X 14"
W-11459	16" X 16"
W-11460	18" X 18"
W-11461	20" X 30"
W-11462	22" X 30"
W-11463	24" X 24"
W-11464	24" X 36"
W-11465	24" X 48"
W-11466	30" X 30"
W-11467	32" X 32"
W-11468	36" X 36"
W-11469	36" X 48"

- 1 or 3 Hour UL "B" Label wall rating.
- Warnock Hersey 1 or 3 hour floor/ceiling rating.
- 2" thick, 20 gauge door, 16 gauge frame.
- Self closing, spring-assisted.
- Stocked with flush key hole. Recessed Universal latch for turning and key lock included.
- Concealed hinge on long dimension.
- Phosphate dipped with gray prime coat.
- Cut opening 3/8" larger for walls.
- Frame opening 1-5/8" larger for ceilings and line opening with 5/8" "X" gypsum board.
- Custom sizes and colors also available - Just Ask Us!!!

DUCT ACCESS DOORS

DRUGA - HIGH PRESSURE - ROUND DUCT ACCESS DOOR - UNINSULATED



DRUGA

The DRUGA high pressure round access door is constructed of a stamped galvanized steel panel and features a neoprene gasket.

- Tested to 20" pos. wg & 10" neg. wg pressure.
- Plastic knobs with brass inserts.
- Cut out template for door provided.
- Uninsulated.

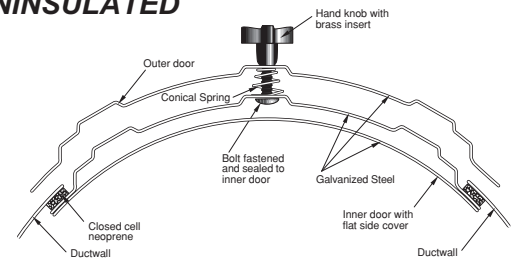

Catalog#	Model	Duct Size
W-11546	DRU846GA	5" - 6"
W-11547	DRU849GA	7" - 9"
W-11548	DRU8411GA	10" - 11"
W-11549	DRU12811GA	10" - 11"
W-11551	DRU12814GA	12" - 14"
W-11552	DRU12816GA	15" - 16"
W-11553	DRU161216GA	15" - 16"
W-11554	DRU161218GA	17" - 18"
W-11555	DRU161220GA	19" - 20"
W-11556	DRU161222GA	21" - 22"
W-11557	DRU161224GA	23" - 24"
W-11558	DRU161228GA	25" - 28"

DUGA - HIGH PRESSURE - SANDWICH DOOR FOR RECTANGULAR DUCT - UNINSULATED

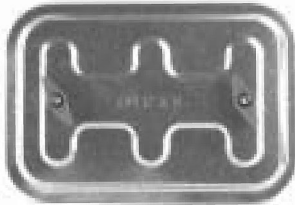

DUGA

The DUGA high pressure sandwich door is constructed of a stamped galvanized steel panel and features a neoprene gasket.

- Tested to 20" pos. wg & 10" neg. wg pressure.
- Plastic knobs with brass inserts.
- Cut out template for door provided.
- Uninsulated.

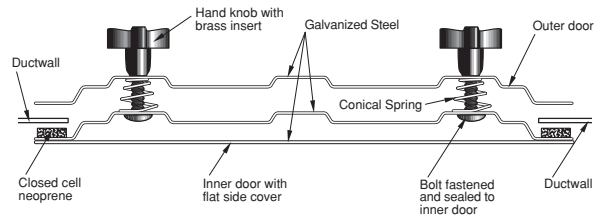

Catalog#	Model	Duct Size
W-11542	DU106GA	10"X6"
W-11543	DU128GA	12"X8"
W-11544	DU1814GA	18"X14"
W-51726	DU2418GA	24"X18"

DC - CIRCULAR CLEAN-OUT DOORS



DCGA

The DC circular clean-out door is airtight and has no frame to install and seal.

- Circular opening effective for duct cleaning.
- Effortless opening and closing.

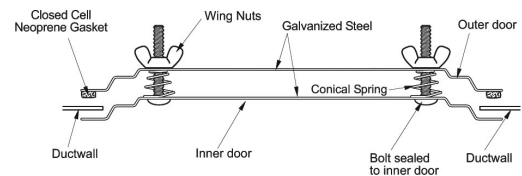

Catalog#	Model	Duct Size
W-11559	DC8GA	8" Diameter
W-11560	DC10GA	10" Diameter
W-12371	DC12GA	12" Diameter

DUCT ACCESS DOORS

DF2GA - HIGH TEMPERATURE GREASE DOORS FOR GREASE DUCT, 2300°F

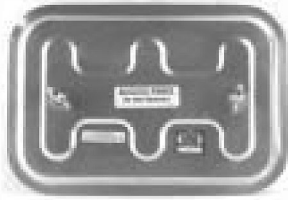

- Cut out template provided.
- Ceramic fiber gasket (2300°F, meets NFPA 96 standards).
- 16 ga. black iron backing plate for grease applications.

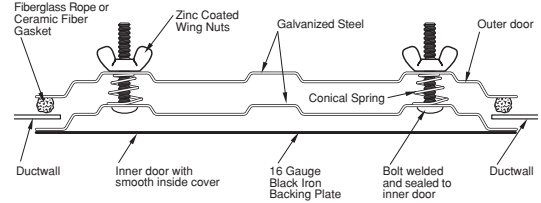

DF2GA

The DF2GA is constructed of stamped sealed panels and features steel wing nuts. An excellent clean-out door.

Catalog#	Model	Duct Size
W-11561	D106F2GA	10" X 6"
W-11562	D128F2GA	12" X 8"
W-11563	D1814F2GA	18" X 14"
W-12339	D2418F2GA	24" X 18"

HAD - HINGED INSULATED DUCT ACCESS DOORS

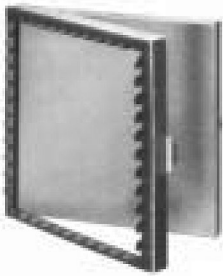

HAD

- High density closed cell gasketing - door to frame & frame to duct.
- Zinc plated continuous steel hinge.
- Thumb-operated steel cam latch(es).
- Hole size is 1" smaller than nominal.

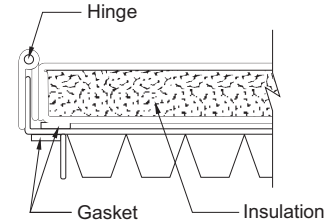

The HAD Hinged Insulated Access Door features galvanized steel construction and 1" high density fiberglass insulation.

Catalog#	Size
W-11523	6" X 6"
W-11524	8" X 8"
W-11525	10" X 10"
W-11526	12" X 12"
W-11527	14" X 14"
W-11528	16" X 16"
W-11529	18" X 18"
W-11530	20" X 20"
W-11531	24" X 24"

CAD - CAMMED DUCT ACCESS DOOR, INSULATED



CAD

- High density closed cell gasketing - door to frame & frame to duct.
- Thumb-operated steel cam latch(es).
- Hole size is 1" smaller than nominal.

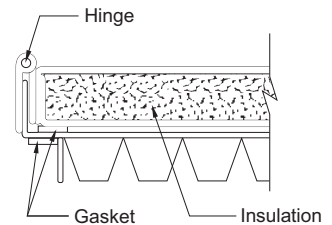

The CAD Duct Access Door features galvanized steel construction and 1" high density fiberglass insulation.

Catalog#	Size
W-12396	6" X 6"
W-12397	8" X 8"
W-12398	10" X 10"
W-12399	12" X 12"
W-12400	14" X 14"
W-12401	16" X 16"
W-12402	18" X 18"
W-12403	20" X 20"
W-12404	24" X 24"

DUCT ACCESS DOORS

HAD-P - HINGED INSULATED DUCT ACCESS DOORS - PRESS-ON FLANGED FRAME

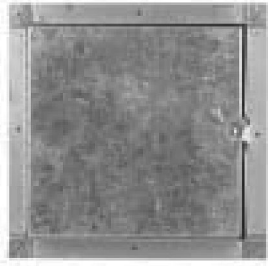

HAD-P

- Double sided adhesive neoprene gasket - for easy installation.
- Zinc plated continuous steel hinge.
- Thumb-operated steel cam latch(es).
- Punched hole start for easy screw flange installation.

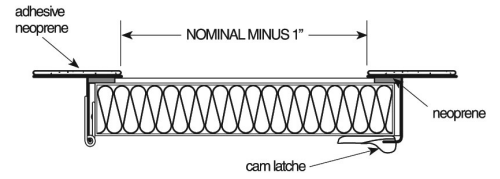

The HAD-P Hinged Insulated Duct Access Door features galvanized steel construction and high density closed cell gasketing from the door to the frame only. Features 1" high density fiberglass insulation.

Catalog#	Size
W-11532	6"X6"
W-11533	8"X8"
W-11534	10"X10"
W-11535	12"X12"
W-11536	14"X14"
W-11537	16"X16"
W-11538	18"X18"
W-11539	20"X20"
W-11540	24"X24"

WAD - WALK-IN INSULATED ACCESS DOOR



WAD

- 1" fiberglass insulation.
- Full length zinc plated continuous vertical hinge.
- Two Ventlock 202 door latches with interior and exterior handles.
- Hole size is nominal.

The WAD Walk-In Insulated Access Door features a 16 gauge galvanized steel frame and 22 gauge galvanized steel double-wall door.

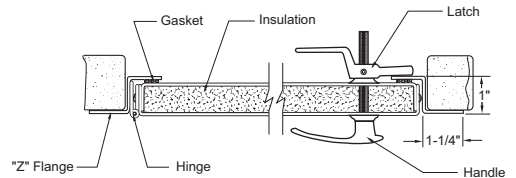

Catalog#	Size
W-11486	18" X 36"
W-11487	18" X 48"
W-11489	24" X 36"
W-11490	24" X 48"
W-11491	24" X 60"
W-12509	24" X 66"
W-11492	24" X 72"

SINGLE DUCT TERMINAL UNITS*

* We can strap two boxes together to make a dual box.

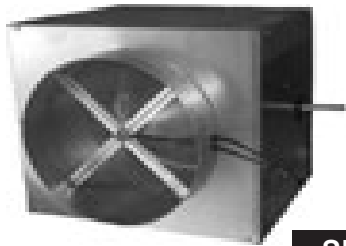

SDV

- ARI Certified sound performance.
- Heavy gauge steel construction.
- Low leakage damper design.
- Thermally insulated inlet tube.
- Acoustically and thermally insulated casing meets UL181 and NFPA 90A requirements.
- Slip and drive discharge connection.
- Damper position indicator mark.
- Electronic controls available.
- Patented Flo-Cross Multipoint Flo-Sensor.
- Also stocked with Insul-Guard (13/16" Rigid Duct Board) lining

Pricing on next page

Model SDV Pneumatic Controls

- Pressure independent.
- Pneumatic actuator.
- Control enclosure optional.
- Damper position indicator on shaft.
- Multifunction controller.
- DA-NO/NC or RA-NO/NC.
- Field calibration required.

Model SDV No Controls

- Unit stocked less controls.
- Control enclosure optional.
- Flo-Cross Multipoint Flo-Sensor.
- 3/8" bare damper shaft.

SDV Dimensional Data

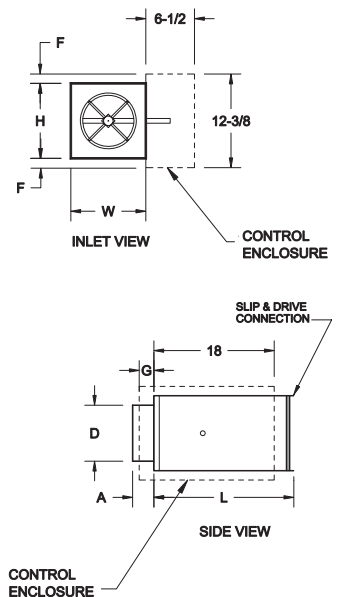

Unit Size	CFM Range Min to Max	Length (L)	Height (H)	Width (W)	Inlet Dimension (D)
6	0/100-520	15-1/2"	8"	12"	5-7/8"
8	0/185-925	15-1/2"	10"	12"	7-7/8"
10	0/290-1450	15-1/2"	12-1/2"	14"	9-7/8"
12	0/420-2100	15-1/2"	15"	16"	11-7/8"
14	0/580-2600	15-1/2"	17-1/2"	20"	13-7/8"
16	0/740-3700	15-1/2"	18"	24"	15-7/8"
24	0/1420-7100	15"	see above	see above	see above

SINGLE DUCT TERMINAL UNITS

SINGLE DUCT TERMINAL UNITS, NO CONTROLS

Catalog#	Size
W-12341	6"
W-12342	8"
W-12343	10"
W-12344	12"
W-12345	14"
W-12346	16"
W-12510	24"X16"

SINGLE DUCT TERMINAL UNITS, PNEUMATIC CONTROLS

Catalog#	Size
W-12347	6"
W-12348	8"
W-12349	10"
W-12350	12"
W-12351	14"
W-12352	16"
W-12511	24"X16"

SINGLE DUCT TERMINAL UNITS, W/ENVIROSEAL LINING, NO CONTROLS

Catalog#	Size
W-12521	6"
W-12522	8"
W-12523	10"
W-12524	12"
W-12525	14"
W-12526	16"
W-12527	24"X16"

OPTIONAL HOT WATER COILS 1 ROW AND 2 ROW

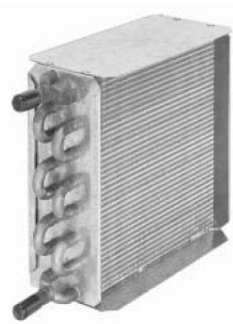

- Copper tubing-aluminum fins.
- Housed in galvanized casing.
- Coil mounts at discharge outlet.
- Slip and drive duct connection.
- Coil ships loose.
- Optional mounting available.

SINGLE DUCT TERMINAL UNITS, W/ENVIROSEAL LINING, PNEUMATIC CONTROLS

Catalog#	Size
W-12528	6"
W-12529	8"
W-12530	10"
W-12531	12"
W-12532	14"
W-12533	16"
W-12534	24" x 16"

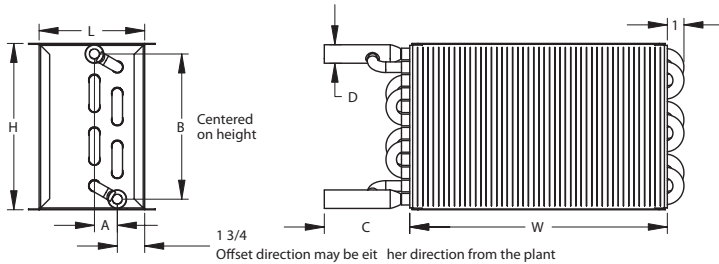

HOT WATER REHEAT COIL, 1-ROW

Catalog#	Size
W-12359	6"
W-12360	8"
W-12361	10"
W-12362	12"
W-12363	14"
W-12364	16"
W-12512	24" x 16"

Offset direction may be either direction from the plant

Measurements in inches				Offset direction may be either direction from the plant								
Size	H	W	L	1 Row				2 Row				
				A	B	C	D	L	A	B	C	D
6	8"	12	5	0	6-1/4	3	1/2	5	0	6-7/8	4-1/4	7/8
8	10	12	5	0	8-3/4	3	1/2	5	1-1/8	9	4-1/4	7/8
10	12-1/2	14	5	1-1/4	10-7/8	4-1/4	7/8	5	1-1/8	11-1/2	4-1/4	7/8
12	15	16	5	1-1/4	13-3/8	4-1/4	7/8	5	1-1/8	14	4-1/4	7/8
14	17-1/2	20	7-1/2	1-1/4	15-7/8	4-1/4	7/8	7-1/2	1-1/8	16-1/2	4-1/4	7/8
16	18	24	7-1/2	1-1/4	15-7/8	4-1/4	7/8	7-1/2	1-1/8	16-1/2	4-1/4	7/8
24	18	38	5	1-1/4	15-7/8	4-1/4	7/8	5	1-1/8	16-1/2	4-1/4	7/8

HOT WATER REHEAT COIL, 2-ROW

Catalog#	Size
W-12365	6"
W-12366	8"
W-12367	10"
W-12368	12"
W-12369	14"
W-12370	16"
W-12512	24" x 16"

SINGLE DUCT TERMINAL UNIT ACCESSORIES

CONTROL ENCLOSURE



Catalog#	Size
W-12695	18" x 12-3/8" x 6-1/2"

OPTIONAL STOCK 3 FOOT ATTENUATORS

- 1" insulation, open both ends.
- S and D drive connections.



3-FOOT ATTENUATOR FOR VAV BOXES

Catalog#	Size
W-12514	6"
W-12515	8"
W-12516	10"
W-12517	12"
W-12518	14"
W-12519	16"
W-12520	24" x 16"

SINGLE DUCT AND DUAL DUCT VAV ACCESSORIES

CONTROLS AND ACCESSORIES



Catalog#	Pneumatic Actuators
W-51160	MCP-3631-3000, 5-10 psi Pneumatic rotary actuator
W-10562	MCP-3631-5000, 8-13 psi Pneumatic rotary actuator
W-12578	MCP-3631-8000, 3-8 psi Pneumatic rotary actuator



Transformer and Disconnect

Catalog#	Size
W-12584	Transformer, 120-24 VAC
W-12585	Disconnect, 120-277 VAC

W-12584



W-12585

LINEAR SLOT DIFFUSERS

LINEAR SLOT DIFFUSERS FROM STOCK OR LOCALLY CUSTOM MADE

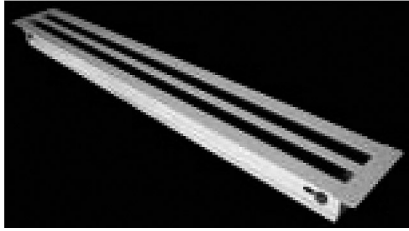

LTSC

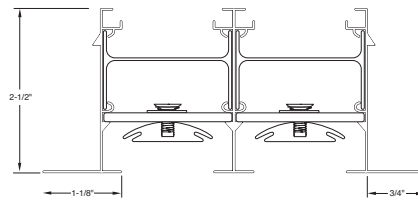

Concealed mounting with hemmed plenum

LTSC Frame

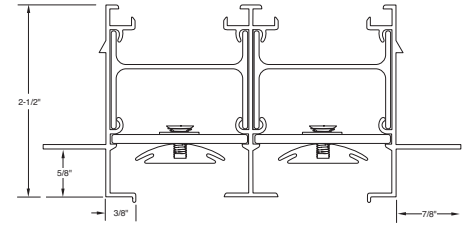

Concealed mounting in hard surfaces

MCS Frame

- Air Managers Linear Slot Diffusers
- Fully adjustable horizontal pattern controller in stock
- 1 slot and 2 slot, 3/4" or 1" slot widths stocked.
- Excellent for VAV applications
- Can be field cut to custom lengths

LINEAR SLOT DIFFUSERS - LTSC FRAME

Catalog#	Size
W-11176	48" x 1 Slot x 3/4"
W-11177	60" x 1 Slot x 3/4"
W-11178	72" x 1 Slot x 3/4"
W-11182	48" x 2 Slot x 3/4"
W-11183	60" x 2 Slot x 3/4"
W-11184	72" x 2 Slot x 3/4"
W-11173	48" x 1 Slot x 1"
W-11174	60" x 1 Slot x 1"
W-11175	72" x 1 Slot x 1"
W-11179	48" x 2 Slot x 1"
W-11180	60" x 2 Slot x 1"
W-11181	72" x 2 Slot x 1"

LINEAR SLOT DIFFUSERS - MCS FRAME

Catalog#	Size
W-12408	48" x 1 Slot x 3/4"
W-12409	60" x 1 Slot x 3/4"
W-12410	72" x 1 Slot x 3/4"
W-12411	48" x 2 Slot x 3/4"
W-12412	60" x 2 Slot x 3/4"
W-12413	72" x 2 Slot x 3/4"
W-12414	48" x 1 Slot x 1"
W-12415	60" x 1 Slot x 1"
W-12416	72" x 1 Slot x 1"
W-12417	48" x 2 Slot x 1"
W-12418	60" x 2 Slot x 1"
W-12419	72" x 2 Slot x 1"

Linear Slot Diffusers feature aluminum construction with end caps or butt caps. They are stocked in a bright white finish with black pattern controller.

MATCHING INSULATED DIFFUSER PLENUMS

- Air Managers insulated linear plenum boot.
- Matching fit for stock linear slot diffusers.
- Galvanized steel construction.
- Stocked in 48", 60" and 72" lengths.

Diffuser Plenums are designed for single diffusers or continuous runs and can be used for supply or return applications. Stocked without inlet collar, must be field cut.



Catalog#	Size
W-12586	48" x 1 Slot x 3/4"
W-12587	60" x 1 Slot x 3/4"
W-12588	72" x 1 Slot x 3/4"
W-12589	48" x 2 Slot x 3/4"
W-12590	60" x 2 Slot x 3/4"
W-12591	72" x 2 Slot x 3/4"
W-12592	48" x 1 Slot x 1"
W-12593	60" x 1 Slot x 1"
W-12594	72" x 1 Slot x 1"
W-12595	48" x 2 Slot x 1"
W-12596	60" x 2 Slot x 1"
W-12597	72" x 2 Slot x 1"

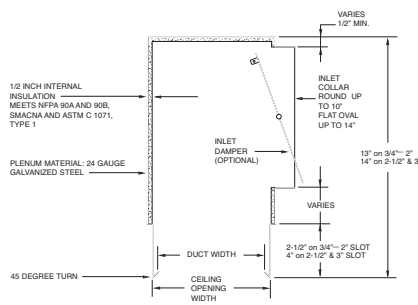

PERFORATED LAY-IN DIFFUSERS

PERFORATED ADJUSTABLE CURVED BLADE LAY-IN T-BAR AND MATCHING RETURN

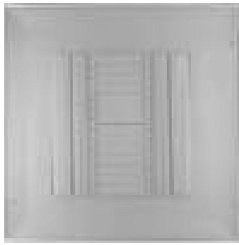

PV

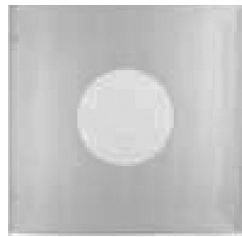

PR

- Tuttle and Bailey curved blade perforated diffuser.
- Round or square neck.
- Unit is standard with adjustable curved blade core in neck.
- Adjustable horizontal to vertical air pattern.
- Diffuser stocked as 4 way blow pattern standard.
- 24" x 24" lay-in ceiling module with removable perforated face.
- White baked enamel finish.



MODEL PV-LT

MODEL PV-NR, Narrow Regress

MODEL PR-LT

MODEL PVR-NR

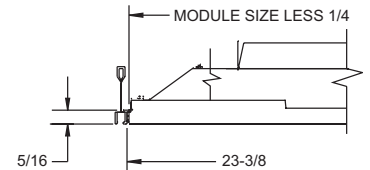
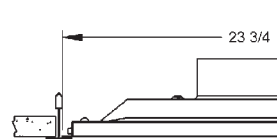
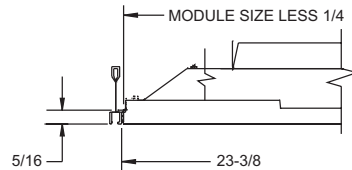
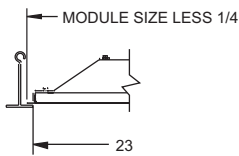

PV-LT, CURVED BLADE, PERFORATED FACE, 24" x 24"--LAY-IN PANEL

PV-NR, CURVED BLADE, PERFORATED FACE, 24" x 24" LAY-IN PANEL, NARROW REGRESS

Catalog#	Size	Max CFM @ NC
W-10213	6"	311@40
W-10214	8"	469@40
W-10215	10"	745@40
W-10216	12"	732@40
W-10217	14"	996@40
W-10218	16"	1094@40
W-10220	6"x6"	314@40
W-10221	8"x8"	473@40
W-10222	10"x10"	639@40
W-10223	12"x12"	840@40
W-10244	14"x14"	1088@40
W-10225	16"x16"	1396@40

Catalog#	Size	Max CFM @ NC
W-10317	6"	311@40
W-10318	8"	469@40
W-10319	10"	745@40
W-10320	12"	732@40
W-10321	14"	996@40
W-10322	16"	1094@40
W-10323	6"x6"	314@40
W-10324	8"x8"	473@40
W-10325	10"x10"	639@40
W-10326	12"x12"	840@40
W-10327	14"x14"	1088@40
W-10328	16"x16"	1396@40

PR-LT, PERFORATED FACE RETURN, 24" x 24" LAY-IN PANEL

PVR-NR, PERFORATED FACE RETURN, 24" x 24" LAY-IN PANEL, NARROW REGRESS

Catalog#	Size	Max CFM @ NC
W-10234	6"	275@34
W-10235	8"	488@38
W-10236	10"	763@41
W-10237	12"	1099@43
W-10238	14"	1495@46
W-10239	16"	1953@49
W-12294	6"x6"	350@35
W-12295	8"x8"	622@39
W-12296	10"x10"	972@42
W-12297	12"x12"	1400@45
W-12298	14"x14"	-
W-12299	16"x16"	-
W-12300	18"x18"	3150@49
W-12302	22"x22"	4706@51

Catalog#	Size
W-10336	6"
W-10337	8"
W-10338	10"
W-10339	12"
W-12355	14"
W-10340	16"
W-10342	6"x6"
W-10343	8"x8"
W-10344	10"x10"
W-10345	12"x12"
W-10346	14"x14"
W-10347	16"x16"

PERFORATED LAY-IN DIFFUSERS

PERFORATED FACE MODULAR CORE LAY-IN T-BAR AND MATCHING RETURN

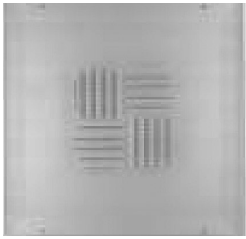

PM

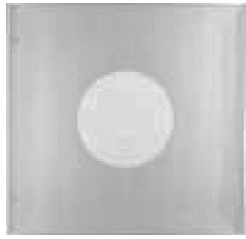

PR

- Tuttle and Bailey modular core perforated diffuser.
- Square neck.
- Removable modular core design.
- Diffuser is adjustable to any blow pattern.
- Diffuser stocked with cores set at 4 way blow standard.
- 24" x 24" lay-in ceiling module with removable perforated face.
- White baked enamel finish.



MODEL PM-LT

MODEL PM-NR, Narrow Regress

MODEL PR-LT

MODEL PVR-NR

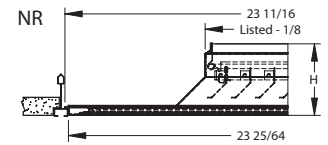
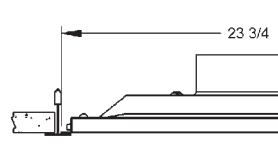
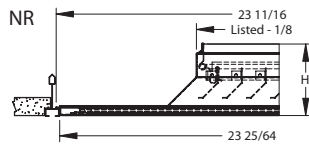
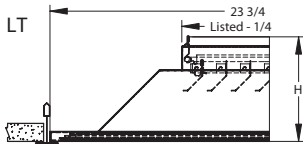

PM-LT, MODULAR CORE, PERFORATED FACE, 24" x 24" LAY-IN PANEL

PM-NR, MODULAR CORE, PERFORATED FACE, 24" x 24" LAY-IN PANEL, NARROW REGRESS

Catalog#	Size	Max CFM @ NC
W-10227	6"x6"	175@22
W-10228	8"x8"	311@27
W-10229	10"x10"	486@31
W-10230	12"x12"	700@35
W-10231	14"x14"	-
W-10232	16"x16"	-
W-10233	18"x18"	-

Catalog#	Size	Max CFM @ NC
W-10329	6"x6"	175@22
W-10330	8"x8"	311@27
W-10331	10"x10"	486@31
W-10332	12"x12"	700@35
W-10333	14"x14"	-
W-10334	16"x16"	-
W-10335	18"x18"	-

PR-LT, PERFORATED FACE RETURN, 24" x 24" LAY-IN PANEL

PVR-NR, PERFORATED FACE RETURN, 24" x 24" LAY-IN PANEL, NARROW REGRESS

Catalog#	Size	Max CFM @ NC
W-10234	6"	275@34
W-10235	8"	488@38
W-10236	10"	763@41
W-10237	12"	1099@43
W-10238	14"	1495@46
W-10239	16"	1953@49
W-12294	6"x6"	350@35
W-12295	8"x8"	622@39
W-12296	10"x10"	972@42
W-12297	12"x12"	1400@45
W-12298	14"x14"	-
W-12299	16"x16"	-
W-12300	18"x18"	3150@49
W-12302	22"x22"	4706@51

Catalog#	Size
W-10336	6"
W-10337	8"
W-10338	10"
W-10339	12"
W-12355	14"
W-10340	16"
W-10342	6"x6"
W-10343	8"x8"
W-10344	10"x10"
W-10345	12"x12"
W-10346	14"x14"
W-10347	16"x16"

PERFORATED LAY-IN DIFFUSERS

PERFORATED FACE MOUNTED ADJUSTABLE AIR PATTERN LAY-IN T-BAR AND MATCHING RETURN

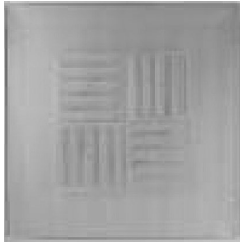

PP

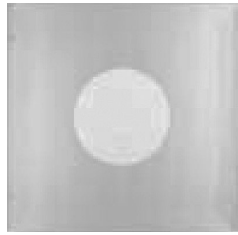

PR

- Tuttle and Bailey economy perforated diffuser.
- Round or square neck.
- Unit is standard with face mounted adjustable air pattern.
- Diffuser is field adjustable to any blow pattern.
- Diffuser stocked with 4 way blow pattern preset.
- 24" x 24" lay-in ceiling module with removable perforated face.
- White baked enamel finish.

MODEL PP-LT

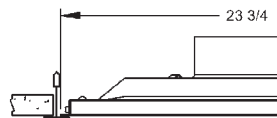

MODEL PR-LT

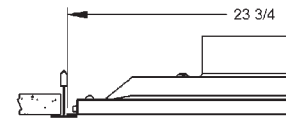

PP-LT, MOUNTED PATTERN DEFLECTORS, PERFORATED FACE, 24" x 24" LAY-IN PANEL

Catalog#	Size	Max CFM @ NC
W-12282	6"	275@43
W-12283	8"	489@49
W-12284	10"	764@54
W-12285	12"	1100@57
W-12286	14"	1497@60
W-12287	16"	1955@63
W-10241	6"x6"	350@45
W-10242	8"x8"	622@51
W-10243	10"x10"	972@56
W-10244	12"x12"	1400@60
W-10245	14"x14"	-
W-10246	16"x16"	-
W-10247	18"x18"	-

PR-LT, PERFORATED FACE RETURN, 24" x 24" LAY-IN PANEL

Catalog#	Size	Max CFM @ NC
W-10234	6"	275@34
W-10235	8"	488@38
W-10236	10"	763@41
W-10237	12"	1099@43
W-10238	14"	1495@46
W-10239	16"	1953@49
W-12294	6"x6"	350@35
W-12295	8"x8"	622@39
W-12296	10"x10"	972@42
W-12297	12"x12"	1400@45
W-12298	14"x14"	-
W-12299	16"x16"	-
W-12300	18"x18"	3150@49
W-12302	22"x22"	4706@51

PERFORATED LAY-IN SCREENS

PERFORATED FACE LAY-IN T-BAR SCREENS

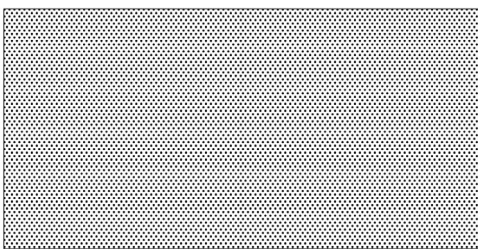

48" x 24"

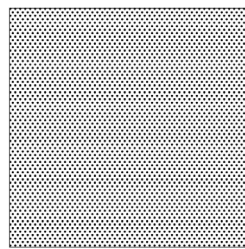

24" x 24"



PTL 24" x 12"

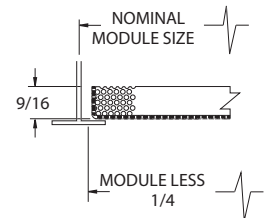

- Steel perforated, non-ducted.
- White baked enamel finish.

PTL-LT, PERFORATED FACE, 24" x 24" LAY-IN PANEL, NON-DUCTED

Catalog#	Size	Max CFM @ NC
W-10963	24"x12"	2548@39
W-10964	24"x24"	5250@42
W-10965	48"x24"	-

PTL-NR, PERFORATED FACE, 24" x 24" LAY-IN PANEL, NON-DUCTED, NARROW REGRESS

Catalog#	Size
W-11171	24"x24"

PERFORATED SURFACE MOUNT

PERFORATED FACE SURFACE MOUNT SUPPLY AND RETURN

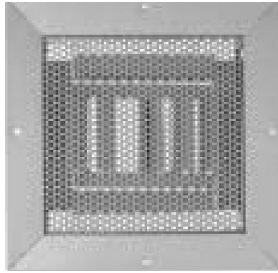

V-PERF-S SUPPLY

- Flat frame construction with screw holes.
- Square neck with removable perforated face.
- Basic curved blade perforated diffuser.
- Diffuser stocked as 4 way blow pattern standard.
- White baked enamel finish.

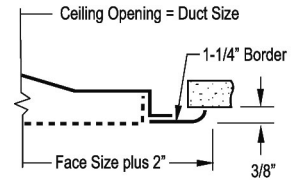

CEILING OPENING IS DUCT SIZE

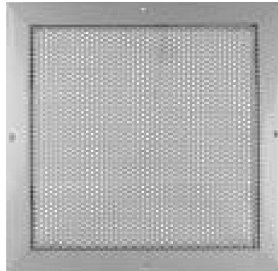

V-PERF-R RETURN

- Flat frame construction with screw holes.
- Square neck with removable perforated face.
- White baked enamel finish.

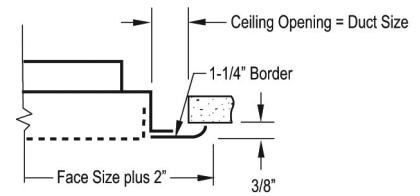

CEILING OPENING IS DUCT SIZE

V-PERF-S, PERFORATED FACE, CURVED BLADE SUPPLY, SURFACE MOUNT

Catalog#	Size
W-10886	6"x6"
W-10887	8"x8"
W-10888	10"x10"
W-10889	12"x12"
W-10890	14"x14"
W-10891	16"x16"
W-10892	18"x18"
W-10893	20"x20"
W-10894	22"x22"
W-10895	24"x24"

V-PERF-R, PERFORATED FACE, RETURN, SURFACE MOUNT

Catalog#	Size
W-10301	6"x6"
W-10302	8"x8"
W-10303	10"x10"
W-10304	12"x12"
W-10305	14"x14"
W-10306	16"x16"
W-10307	18"x18"
W-10308	20"x20"
W-10309	22"x22"
W-10310	24"x24"

MODULAR CORE DIFFUSERS

MODULAR CORE T-BAR LAY-IN AND SURFACE MOUNT

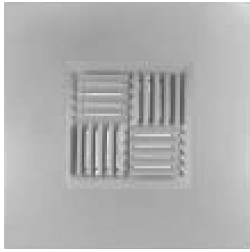

SQD-LT

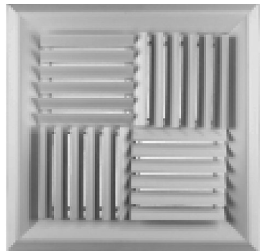

SQD-SB

- Square neck.
- Each individual core can be removed and rotated to provide the required air pattern.
- T-bar lay-in and surface mount units stocked.
- White baked enamel finish.

Note: SOBD's will not fit these diffusers, you must use SMOBD's.

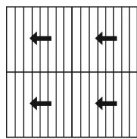
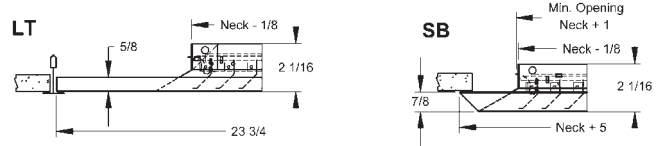

1-Way

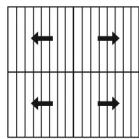

2-Way Opposite

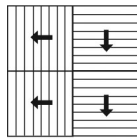

2-Way

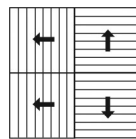

3-Way

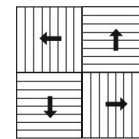

4-Way

SQD-SB, MODULAR CORE, BEVELED FRAME, SURFACE MOUNT

SQD-LT, MODULAR CORE, 24" x 24" LAY-IN PANEL

Catalog#	Size	Max CFM @ NC
W-10131	6"x6"	275@28
W-10132	8"x8"	489@33
W-10133	10"x10"	764@38
W-10134	12"x12"	1100@41
W-10135	14"x14"	1497@44
W-10136	16"x16"	1956@47
W-10137	18"x18"	2475@49

Catalog#	Size	Max CFM @ NC
W-10122	6"x6"	275@28
W-10123	8"x8"	489@33
W-10124	10"x10"	764@38
W-10125	12"x12"	1100@41
W-10126	14"x14"	1497@44
W-10127	16"x16"	1956@47
W-10128	18"x18"	2475@49
W-10129	20"x20"	3056@52
W-10130	22"x22"	3697@53
W-12599	24"x24"	4400@55

ARCHITECTURAL CEILING PLAQUE DIFFUSER LAY-IN

PLAQUE DIFFUSER T-BAR LAY-IN

Tuttle and Bailey lay-in plaque diffusers feature a round neck connection and a choice of six round neck sizes. The all stamped process means no miter lines or unsightly fasteners.

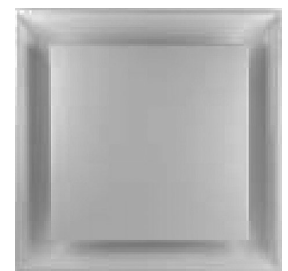
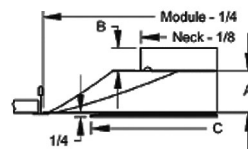

T-1100

T-1100, ARCHITECTURAL PLAQUE DIFFUSER, 24" x 24" LAY-IN PANEL

Catalog#	Size	Max CFM @ NC
W-12322	6"	280@34
W-12323	8"	490@38
W-12324	10"	770@41
W-12325	12"	1100@43
W-12326	14"	1500@43
W-12327	15"	1720@46

- Diffuser model is 24" square.
- May be used for supply or return.
- 1-1/4" collar for easy duct connection.
- White baked enamel finish.
- Removable plaque face.

LOUVERED FACE CEILING DIFFUSERS - Lay-in and Surface Mount

LOUVERED FACE LAY-IN AND SURFACE MOUNT DIFFUSER

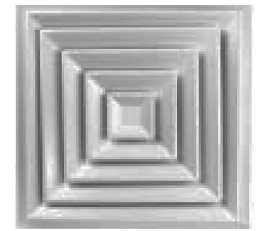
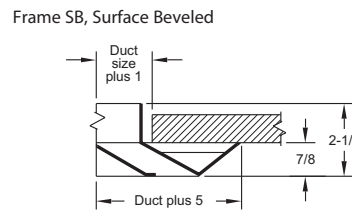
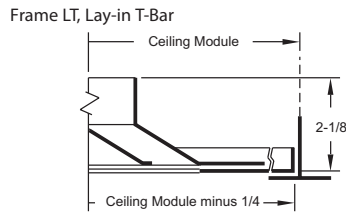

M-LT

- Tuttle and Bailey louvered face diffuser.
- Square neck sizes stocked in 3" increments.
- 4-way fixed air pattern stocked.
- Surface mount ceiling opening is duct plus 1".
- Inner assembly spring loaded and removable.

M-SB

- Excellent for vav and cold air devices.
- White baked enamel finish.
- Removable core.
- Surface mount is beveled frame.

Note: SOBD's will not fit these diffusers, you must use SMOBD's.

M-LT, LOUVERED FACE DIFFUSER, 24" x 24" LAY-IN PANEL

Catalog#	Size	Max CFM @ NC
W-10208	6"x6"	225@34
W-10209	9"x9"	506@37
W-10210	12"x12"	900@37
W-10211	15"x15"	1406@40
W-12600	18"x18"	2025@41
W-12394	21"x21"	2756@42

M-SB, LOUVERED FACE DIFFUSER, SURFACE MOUNT, BEVELED FRAME

Catalog#	Size	Max CFM @ NC
W-10201	6"x6"	225@34
W-10202	9"x9"	506@37
W-10203	12"x12"	900@37
W-10204	15"x15"	1406@40
W-10205	18"x18"	2025@41
W-12601	21"x21"	2756@42

CURVED BLADE CEILING DIFFUSERS - Surface and Exposed Mount

CURVED BLADE SURFACE MOUNT CEILING DIFFUSERS



- TRU AIRE adjustable curved blade ceiling diffuser.
- Also designed for low sidewall, high sidewall applications.
- White baked enamel finish.
- Curved Blade Surface Mount Ceiling Diffusers feature a 4 way fixed discharge pattern
- Excellent for vav and cold air devices.

Catalog#	Size
W-10176	6"x6"
W-10177	8"x8"
W-10179	10"x10"
W-10181	12"x12"
W-10182	14"x14"
W-12373	16"x16"
W-10184	18"x18"

THERMALLY POWERED VAV PLAQUE DIFFUSER

VSD-4, RICKARD THERMALLY POWERED VAV PLAQUE DIFFUSER FOR LAY-IN



VSD-4

- Thermally Actuated using Wax Bulb Technology.
- 10 Yr. Replacement Parts Warranty.
- No Electrical Requirements.
- No Tools Needed to Set Temperature Setpoints.
- Reversing Changeover.
- No Routine Maintenance Required.
- Self Contained • ARI Certified.

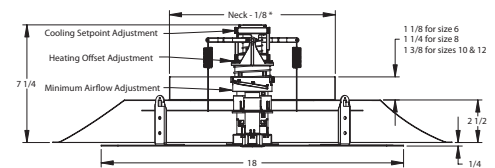
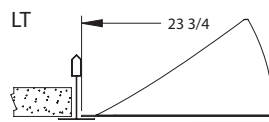

Catalog#	Size	Max CFM @ NC
W-12602	6"	196@25
W-12603	8"	349@28
W-12604	10"	545@34
W-12605	12"	785@44

ROUND NECK STAMPED LOUVERED DIFFUSER LAY-IN



HIGH VOLUME SQUARE FACE LOUVERED DIFFUSER

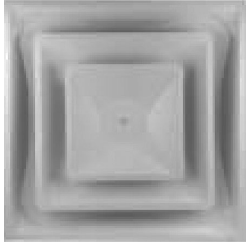

- Excellent performance for both vav and cold air devices.
- Choice of six round neck sizes.
- Diffuser module is 24" square.
- 1-1/4" collar for easy duct connection.
- White baked enamel finish.
- Earthquake tabs standard.

S1200-LT

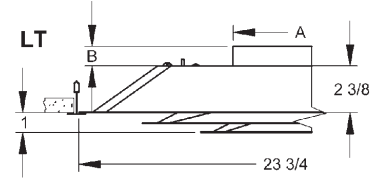

S1200-LT, ROUND NECK 2-CONE LOUVERED FACE DIFFUSER, LAY-IN

Tuttle and Bailey high volume 2 cone louvered face diffuser is constructed with a stamped process which features no miter lines or unsightly fasteners. The anti-streak, anti-smudge design keeps your ceiling clean.

Catalog#	Size	Max CFM @ NC
W-10195	6"	216@29
W-10196	8"	384@33
W-10197	10"	600@36
W-10198	12"	864@39
W-10199	14"	1069@38
W-10200	15"	1227@38

ROUND FACE FIXED DISCHARGE CONE DIFFUSER

HIGH CAPACITY ROUND FACE DIFFUSER - Exposed or Surface Mount

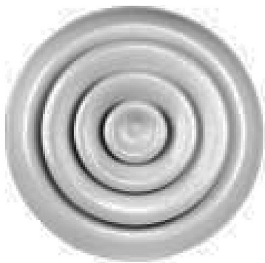

- Tuttle and Bailey round face high capacity diffuser.
- Heavy gauge steel construction.
- Core is easily removed for installation or maintenance.
- Stocked in 2" increments.
- Two horizontal discharge settings.
- Center button is removable for access to damper (not included).
- White baked enamel finish.

P3

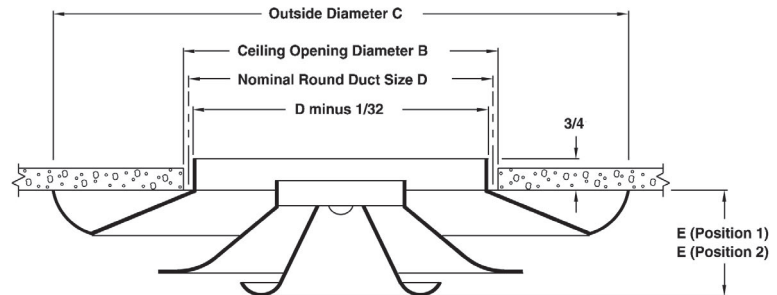

P3, THREE CONE ROUND CEILING DIFFUSER

Catalog#	Size	Max CFM @ NC POS1.2
W-10187	6"	275@37/42
W-10188	8"	490@39/44
W-10189	10"	763@41/45
W-10190	12"	1100@43/46
W-10191	14"	1490@44/47
W-10192	16"	1960@45/48
W-10193	18"	2480@41/44
W-12606	20"	3060@47/49
W-12650	24"	4400@49/50

Nominal Round Duct Size D	B	C	E (Pos. 1)	E (Pos. 2)
06	6-1/2	11-1/8	1-3/4	1-1/8
08	8-1/2	14-3/4	2-1/8	1-1/2
10	10-1/2	18-1/4	2-7/8	2-1/8
12	12-1/2	22	3-1/8	2-3/8
14	14-1/2	26	3-3/8	2-5/8
16	16-1/2	29	4	3-1/4
18	18-1/2	32-1/2	4-3/4	3-7/8
20	20-1/2	36	5-7/8	4-7/8
24	24-1/2	43-1/4	7-3/4	6-5/8

STATIONARY RETURN GRILLE

STEEL BAR STYLE RETURN GRILLE - EXPOSED OR SIDEWALL SURFACE MOUNT



- Steel fixed horizontal blades on 3/4" centers.
- Steel 1-1/4" flat border frame with screw holes.
- Countersunk screw holes and mounting screws.
- Blades are fixed at 35 degree deflection.

T70D

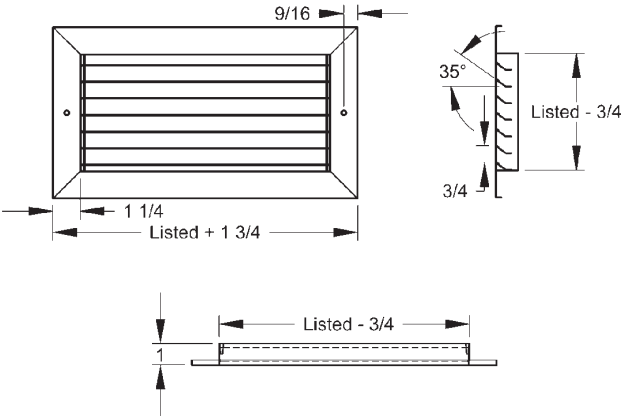

T70D-LT FIXED BAR STYLE RETURN GRILLE, LAY-IN

Catalog#	Size
W-10114	6"x6"
W-10115	8"x8"
W-10116	10"x10"
W-10117	12"x12"
W-10118	14"x14"
W-10119	16"x16"
W-10120	18"x18"
W-10121	22"x22"

T70D FIXED BAR STYLE RETURN GRILLE, SURFACE MOUNT

Catalog#	Size
W-10437	6"x6"
W-10438	8"x4"
W-10439	8"x6"
W-10440	8"x8"
W-10441	10"x4"
W-10442	10"x6"
W-10443	10"x8"
W-10444	10"x10"
W-10445	12"x4"
W-10446	12"x6"
W-10447	12"x8"
W-10448	12"x10"
W-10449	12"x12"
W-10450	14"x4"
W-10451	14"x6"
W-10452	14"x8"
W-10453	14"x10"
W-10454	14"x12"
W-10455	14"x14"
W-10456	16"x4"
W-10457	16"x6"
W-10458	16"x8"
W-10459	16"x10"
W-10460	16"x12"
W-10461	16"x14"
W-10462	16x16
W-10463	18"x4"
W-10464	18"x6"
W-10465	18"x8"
W-10466	18"x10"
W-10467	18"x12"
W-10468	18"x14"
W-10469	18"x16"
W-10470	18"x18"
W-10471	20"x4"
W-10472	20"x6"
W-10473	20"x8"
W-10474	20"x10"
W-10475	20"x12"
W-10476	20"x14"
W-10477	20"x16"

Catalog#	Size
W-10478	20"x18"
W-10479	20"x20"
W-12623	22"x10"
W-10480	22"x22"
W-10481	24"x4"
W-10482	24"x6"
W-10483	24"x8"
W-10484	24"x10"
W-10485	24"x12"
W-10486	24"x14"
W-10487	24"x16"
W-10488	24"x18"
W-10489	24"x20"
W-10490	24"x24"
W-10491	30"x4"
W-10492	30"x6"
W-10493	30"x8"
W-10494	30"x10"
W010495	30"x12"
W-10496	30"x14"
W-10497	30"x16"
W-10498	30"x18"
W-10499	30"x20"
W-10500	30"x24"
W-10501	30"x30"
W-10502	36"x6"
W-10503	36"x8"
W-10504	36"x10"
W-10505	36"x12"
W-10506	36"x14"
W-10507	36"x16"
W-10508	36"x18"
W-10509	36"x20"
W-10510	36"x24"
W-12624	36"x30"
W-12625	36"x36"
W-12626	46"x22"
W-12627	48"x12"
W-12628	48"x24"
W-12629	48"x36"
W-12630	48"x48"

BAR STYLE FILTER GRILLE

STEEL BAR STYLE FILTER GRILLES FOR T-BAR



- Steel filter frame for 1" filter.
- Hinged parallel to blades.
- Screw driver latches.
- White baked enamel finish.
- Filters not included.

S90H-FF-TB

Catalog#	Size
W-10516	20"x20"
W-12636	44"x20"

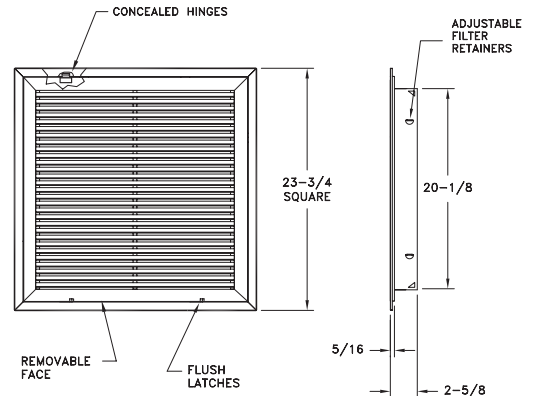

DOUBLE DEFLECTION BAR TYPE SUPPLY REGISTERS

STEEL SUPPLY REGISTER - EXPOSED OR SIDEWALL SURFACE MOUNT

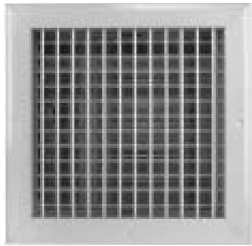

T64

- Steel adjustable vertical face bars and horizontal back bars on 3/4" center.
- 1-1/4" flat border frame with screw holes.
- Countersunk screw holes and mounting screws included.
- Polyurethane foam gasket included on frame.
- Steel OBD damper included.
- White baked enamel finish.

Damper Detail

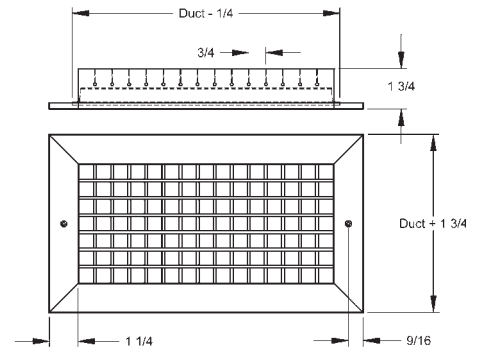
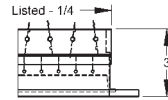

T64, DOUBLE DEFLECTION BAR TYPE SUPPLY REGISTER W/OBD

Catalog#	Size
W-10686	6"x4"
W-10687	6"x6"
W-10688	8"x4"
W-10689	8"x6"
W-10690	8"x8"
W-10691	10"x4"
W-10692	10"x6"
W-10693	10"x8"
W-10694	10"x10"
W-10695	12"x4"
W-10696	12"x6"
W-10697	12"x8"
W-10698	12"x10"
W-10699	12"x12"
W-10700	14"x4"
W-10701	14"x6"
W-10702	14"x8"
W-10703	14"x10"
W-10704	14"x12"
W-10705	14"x14"
W-10706	16"x4"
W-10707	16"x6"
W-10708	16"x8"
W-10709	16"x10"
W-10710	16"x12"

Catalog#	Size
W-10711	16"x14"
W-10712	16"x16"
W-10713	18"x4"
W-10714	18"x6"
W-10715	18"x8"
W-10716	18"x10"
W-10717	18"x12"
W-10718	18"x14"
W-12607	18"x16"
W-10719	18"x18"
W-10720	20"x4"
W-10721	20"x6"
W-10722	20"x8"
W-10723	20"x10"
W-10724	20"x12"
W-10725	20"x14"
W-12608	20"x16"
W-12609	20"x20"
W-10726	24"x4"
W-10727	24"x6"
W-10728	24"x8"
W-10729	24"x10"
W-10730	24"x12"
W-10731	24"x14"
W-12610	24"x16"

Catalog#	Size
W-12611	24"x18"
W-12612	24"x20"
W-10732	24"x24"
W-10733	30"x4"
W-10734	30"x6"
W-10735	30"x8"
W-10736	30"x10"
W-10737	30"x12"
W-10738	30"x14"
W-12613	30"x16"
W-12614	30"x18"
W-12615	30"x20"
W-12616	30"x24"
W-12617	30"x30"
W-12313	36"x6"
W-12314	36"x8"
W-12308	36"x10"
W-12309	36"x12"
W-12310	36"x14"
W-12618	36"x16"
W-12619	36"x18"
W-12620	36"x20"
W-12621	36"x24"
W-12622	36"x30"

STEEL AUXILIARY MOUNTING FRAME - Conversion From T-Bar to Surface

MODEL SMF 24" x 24"

- Enables fast and efficient installation of a T-Bar diffuser or grille in a hard or plaster ceiling.
- Easy and simple installation.
- Allows easy access to ceiling plenum space.
- Wide flange provides a clean look.
- White baked enamel finish.
- Mounting hardware included.
- Recommended ceiling opening is module size plus 1/4".

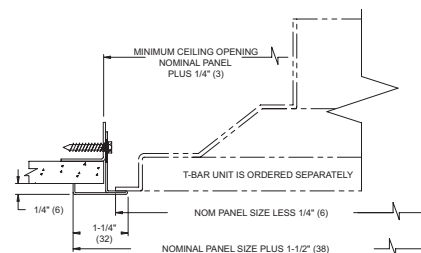

SMF

Catalog#

W-11375

ALUMINUM EGG-CRATE RETURN GRILLE - Lay-In and Surface Mount

MODEL CRE500-LT AND CRE500-SF SURFACE MOUNT

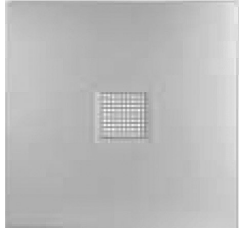

CRE500-LT

- Aluminum cube core 1/2" x 1/2" x 1/2".
- Aluminum 1-1/4" flat frame with screw holes.
- T-bar units stocked with 24" x 24" panels.
- Furnished with countersunk screw holes and mounting screws for surface mount units.
- White baked enamel finish.

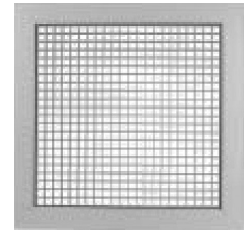

CRE500-SF

CRE500-LT, EGG-CRATE RETURN GRILLE, LAY-IN

Catalog#	Size
W-10291	6"x6"
W-10292	8"x8"
W-10293	10"x10"
W-10294	12"x12"
W-10295	14"x14"
W-10296	16"x16"
W-10297	18"x18"
W-10298	20"x20"
W-10299	22"x22"
W-10300	46"x22"

CRE500-SF, EGG-CRATE RETURN GRILLE, SURFACE MOUNT

Catalog#	Size
W-10279	6"x6"
W-10280	8"x8"
W-10281	10"x10"
W-10282	12"x12"
W-10283	14"x14"
W-10284	16"x16"
W-10285	18"x18"
W-10286	20"x20"
W-10287	22"x22"
W-10288	24"x24"
W-10289	46"x22"

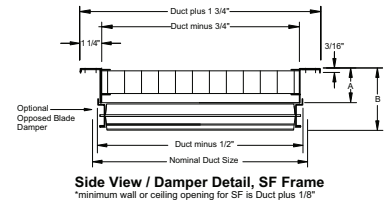
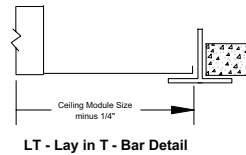

SINGLE DEFLECTION MULTI-SHUTTER SUPPLY REGISTERS

STEEL SUPPLY REGISTER - EXPOSED OR SIDEWALL SURFACE MOUNT

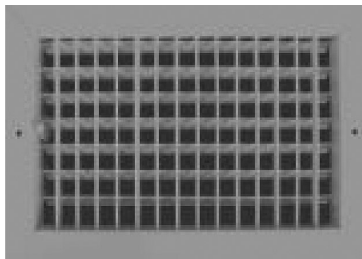

900V

- Steel adjustable vertical face bars.
- Multi-louver damper included.
- White baked enamel finish.

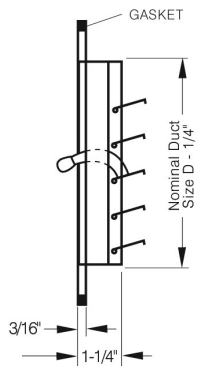

Catalog#	Size
W-10746	6"x6"
W-10747	8"x4"
W-10748	8"x6"
W-10749	8"x8"
W-10750	10"x4"
W-10751	10"x6"
W-10752	10"x8"
W-10753	10"x10"
W-10754	12"x4"
W-10755	12"x6"
W-10756	12"x8"
W-10757	12"x10"
W-10758	12"x12"
W-10759	14"x4"
W-10760	14"x6"
W-10761	14"x8"
W-10762	14"x10"
W-10763	14"x12"
W-10764	14"x14"
W-10765	16"x4"
W-10766	16"x6"
W-10767	16"x8"
W-10768	16"x10"
W-10769	16"x12"
W-10770	16"x14"

Catalog#	Size
W-10771	16"x16"
W-10772	18"x4"
W-10773	18"x6"
W-10774	18"x8"
W-10775	18"x10"
W-10776	18"x12"
W-10777	18"x14"
W-10778	18"x18"
W-10779	20"x4"
W-10780	20"x6"
W-10781	20"x8"
W-10782	20"x10"
W-10783	20"x12"
W-10784	20"x14"
W-10786	24"x4"
W-10787	24"x6"
W-10788	24"x8"
W-10789	24"x10"
W-10790	24"x12"
W-10791	24"x14"
W-12376	24"x24"
W-12631	30"x4"
W-12632	30"x6"
W-12633	30"x8"
W-12634	30"x10"
W-12635	30"x12"
W-12337	30"x14"

DOOR LOUVERS

STEEL FIRE RATED 1900A DOOR LOUVER STEEL NON-RATED 700A DOOR LOUVER



1900A



700A

The 1900A is constructed of 16 gauge steel and the 700A is constructed of 18 gauge steel. Both have a bronze baked enamel finish.

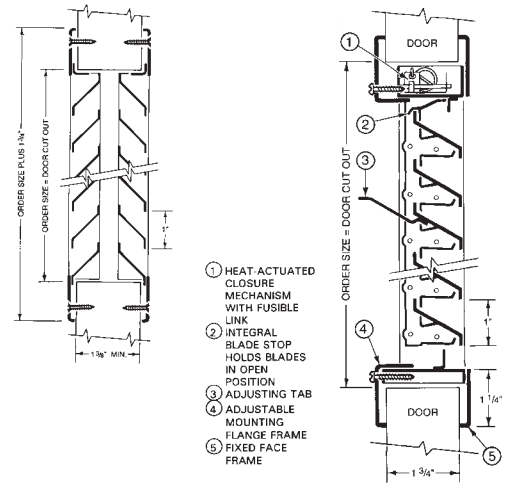

1900A, Steel, Fire-Rated

Catalog#	Size
W-11315	12x12
W-11316	14x14
W-11317	16x16
W-11318	18x12
W-11319	18x18
W-11320	24x12
W-11321	24x18
W-11322	24x24

700A, Steel, Non-Rated

Catalog#	Size
W-11307	12x12
W-11308	14x14
W-11309	16x16
W-11310	18x12
W-11311	18x18
W-11312	24x12
W-11313	24x18
W-11314	24x24

- #8 x 3/4 Phillips screw fasteners.
- 1900A UL fire rated for use in fire doors with up to a 1-1/2 hour rating
- Free area: 50%-700A, 45%-1900A.

2" DEEP STEEL LOUVER

EXTERIOR 2" DEEP SL245-F BONDERIZED STEEL LOUVER



SL245-F

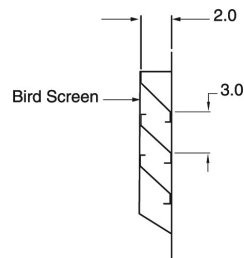

2" Steel louver has a bonderized 26 gauge steel frame and blades with a 45 degree blade profile. It features all spot welded construction.

Steel Louver, Flanged Frame

Catalog#	Size
W-12357	8x8
W-11323	10x10
W-11324	12x12
W-11325	14x14
W-11326	16x16
W-11327	18x18
W-11328	20x20
W-11329	24x24

- 45 degree blade profile.
- Slim 2" deep profile.
- 1-1/2" bonderized steel flange standard.
- 1/4" mesh bird screen standard.
- All units supplied 1/4" under nominal size.



ROUND OPPOSED BLADE DAMPER - For Round Neck Applications



RON

- Blades are gang-operated via flat blade screwdriver from below.
- Steel construction.
- Gray baked enamel finish.

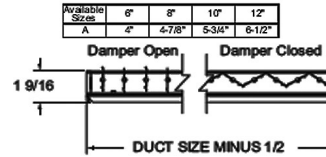
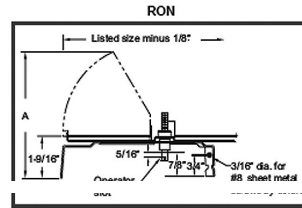

Catalog#	Size
W-10272	6"
W-10273	8"
W-10274	10"
W-10275	12"

Round Opposed Blade Dampers snap into position in diffusers without requiring the use of tools, for a more efficient installation.

SQUARE OPPOSED BLADE DAMPER - For Square Neck Diffusers and Grilles

MODEL SOBD

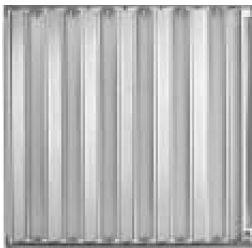

SOBD

- Gang-operated blades.
- Damper operates with medium size flat blade screwdriver.
- Electrogalvanized steel construction.
- Tools-free mounting
- Includes mounting pins. Pins install by finger pressure.

Catalog#	Size
W-10252	6"x6"
W-10254	8"x8"
W-10258	10"x10"
W-10260	12"x12"
W-10263	14"x14"
W-10265	16"x16"
W-10266	18"x18"
W-10268	20"x20"
W-10270	22"x22"
W-10271	24"x24"

MODEL SMOBD - For use with SQD, M, PR & PV Series

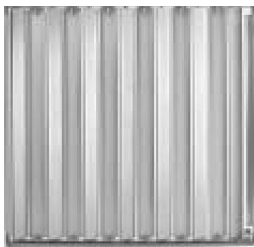

SMOBD

- Gang-operated blades.
- Damper operates with medium size flat blade screwdriver.
- Electrogalvanized steel construction.
- Tools-free mounting
- Includes mounting pins. Pins install by finger pressure.

Catalog#	Size
W-12654	6" x 6"
W-12665	8" x 8"
W-12655	9" x 9"
W-12666	10" x 10"
W-12656	12" x 12"
W-12667	14" x 14"
W-12657	15" x 15"
W-12668	16" x 16"
W-12658	18" x 18"
W-12669	20" x 20"
W-12659	21" x 21"
W-12670	22" x 22"
W-12671	24" x 24"

ROUND NECK OPPOSED BLADE DAMPER

MODEL ROD



ROD

- Blades are gang-operated for quick adjustment.
- Adjustment is via flat-blade screwdriver from below the face of the diffuser.
- Duct mounted, not recommended for use in flexible ducts.

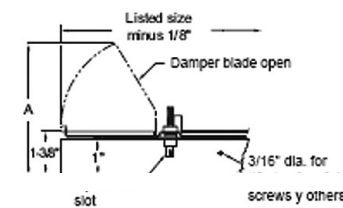

Available Sizes	6"	8"	10"	12"
A	4-1/4"	5-1/8"	6"	6-7/8"

Catalog#	Size
W-12637	6"
W-12638	8"
W-12639	10"
W-12640	12"
W-12641	14"
W-12642	16"
W-12643	18"
W-12644	20"
W-12645	24"

Standard finish is 6"-12" Mill or 14"-24" Black enamel

AIR TECH SALES

Manufacturer's Representative for the HVAC Industry Since 1977

SALAD COSMOS, DIXON, CA



PANA PACIFIC, FRESNO, CA



DUBLIN HIGH SCHOOL, DUBLIN, CA



CLOVIS WEST HIGH SCHOOL, CLOVIS, CA



1830 Vernon Street Suite 2
Roseville, CA 95678

Phone: (916)969-6730
Fax: (916)782-7550

www.airtechsales.com